

Study on Quantitative Evaluation of Energy-saving Techniques for Non-Residential Building

Minami HONDA*¹ Gyuyoung YOON*² Saya YOSHIOKA*³
Takeshi WATANABE*⁴ Masaya OKUMIYA*⁵

*1 Graduate student, Graduate School of Design & Architecture, Nagoya City University.

*2 Associate Prof., Graduate School of Design & Architecture, Nagoya City University.

*3 Hitachi Architects & Engineers, M. Eng.

*4 NTT Facilities INC., Dr. Eng.

*5 Professor, Graduate School of Environmental Studies, Nagoya University, Dr. Eng.

ABSTRACT

This is a study focused on energy-saving guidelines for non-residential buildings. These guidelines are important in order to promote and spread the implementation of the energy-saving techniques in HVAC system for non-residential buildings.

In this study, three factors are taken into consideration (i.e., thermal load factor, design factor and operational factor) which affect the energy consumption of the buildings. Then, a case study concerning these factors is conducted and the effects were compared with various energy-saving techniques.

To evaluate the energy saving technique by the Life Cycle Energy Management tool (LCEM), we assumed model buildings as prevailing office buildings.

As for thermal load factor, we set internal heat gain caused by office automation facilities, 20W/m², 40W/m² and 60W/m² respectively. As for operational factors, we supposed that different cases result in different usage ratio since usage seemed vital in different aspects.

In this paper, we evaluated 6 energy-saving techniques [i.e., optimization (for intake outside air volume), total heat exchanger, suitable fans, adaptation of VAV (Variable Air Volume) control, adaptation of VWV(Variable Water Volume) control, and preventing of short-circuit in outdoor units.

KEYWORDS

Energy-saving techniques, LCEM tool, Non-residential building, Quantitative evaluation

* Corresponding author email: yoon@sda.nagoya-cu.ac.jp

INTRODUCTION

Recently, reduction of CO₂ emissions is required in many countries to stop increasing global heating every year, and there is no exception to Japan. Furthermore, implementation and penetration of energy saving techniques have to hurry for stabilization of energy demand and make necessary supplies after earthquake disaster. Under such circumstances, it is said that energy saving on residence sector is strongly required in view of ratio of final energy and transition until now.

This study is focusing on technique energy saving guidelines, in order to promote implementation and penetration of energy saving techniques for non-residential buildings and facilities by showing the effects quantitatively. Clarifying of cost effectiveness will make easy to apply the measures. Possibly, it can also offer a basic data for ZEB, ZEH or policy planning and contribute to expansion of implementation and penetration of energy saving techniques.

First, we classified factors that affect the energy consumption of the buildings into three factors.

Then a case study concerning thermal load factor and operational factor from three factors is conducted and compared the effects of their application in various energy saving techniques.

1. Factors that affect the air conditioning energy consumption of buildings

Factors that affect the air conditioning energy consumption of buildings are shown in Figure-1. We can say that energy consumption depends on heat load of sizes, attitude of system design and operating systems. Factors that affect were taken into account. Table1 shows the list of each factor.

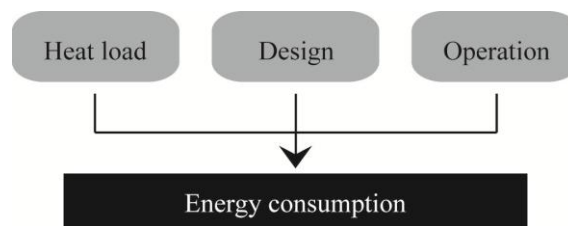

Figure1. Factors that affect the air conditioning energy consumption

Table1. A list of each factor

Large classification	Small classification
Heat load	Area
	Outer skin performance: Performance of insulation, Performance of solar shading
System design	Building purpose and feature : Scale,Height,Shape , Direction,internal heat intensity,intake outside volume,secondary-side air conditioning system
	Calculating peak load measure : Micro-Peak,architectural equipment design standard
	Air-conditioning system: CAV, VAV etc
	Equipment selection: equipment feature,capacity,number division etc
Operation management	Building constraint conditon : place of machine room etc
	Degree of use and running: lighting , office automation facility, preset temparature etc
	System operation and management,control: start and end operation time etc

2. Outline of quantitative evaluation of energy-saving techniques

First, we assumed model buildings to evaluate the effects by applying energy-saving techniques. Air-conditioning system for model buildings was designed, and then conducted the energy simulation by using the Life Cycle Energy Management (LCEM) tool.

Heat load factors were conducted and compared system energy performances depending on various office automation heat release intensity. As for office automation heat release intensity, we set 20W/m² assuming an ordinary office, and 40W/m², 60W/m² assuming heavy duty as design conditions consulting technical guide.

For the operational factors, first we conducted case assumed internal heat intensity of office automation (100% of design-time), and case assumed usage rate is operated down to 50% due to brownout measures. Table 2 shows the underlined condition as in basic standard.

Table2. Case study conditions

Factors	Heat load factor	Operational factors
	(OA equipment heat)	(Usage ratio*1)
Study conditions	20W/m ² • <u>40W/m²</u> • 60W/m ²	<u>100%</u> • 50%

Table3. Examination item of quantification assess a list of energy saving method)

	Outline	Guideline	Grouping
Case1	Optimization for intake outside air volume.	p. 94	Controlling outside air
Case2	Introduction total heat exchanger. (Efficiency of enthalpy 50%)	p. 94	
Case3	Choose suitable fan.	p. 106	Air conditioning system
Case4	Adaptation of VAV control.	p. 112	
Case5	Adaptation of VAV control.	p. 118	HeatsSource

Table 3 shows the quantitative evaluation of this study. These were extracted from energy

saving technique indications. Simulations of each measure were implemented converting under the required contents.

In case1, varies intakes were conducted depending on inside the number of residence. In case 3, which we assumed fan designed static pressure of air supply fan, was overrated as 1.6 times (800Pa). In case 6, we assumed that heat source inner temperature is 5 degree C. during summer and -5 degree C. during winter caused by short- circuit. Evaluation indicators of simulation results are primarily energy consumption for air-conditioning. And also we compared energy consumption of the cases which complement the energy-saving measure or not.

3. Simulated building and system outline

The simulated building is an office building located in Tokyo, Japan, which consists of 10 storey with total floor area of 5,000 m², typical floor area is 500 m². Figure 2 show the typical floor. figure 3 and table 4 show details of the construction of the walls, and value of PAL is 267MJ/m².

Table5 shows the operation conditions of indoor environment and air conditioning. In summer (from June to September), the setting air temperature is 26 degree C.

Table6 shows conditions of internal heat and figure3 shows schedules of internal heat. Air-conditioning system was designed under these conditions. Figure4 shows system diagram. Secondary-side of air conditioning system consists of air handling units and Fan coil units which covers perimeter zone. For primary-side of air conditioning system has one pump system is designed, and capacity of heat source and air-conditioning equipment is selected by using of peak heat load calculated by Micro-peak. Table7 shows equipment list of air conditioning system-(only the case of OA equipment heat density is 40W/m²). Figure5 shows performance curve of heat source equipments, and it shows only curves for heat source system designed for OA equipment of heat density with 40W/m². Since performance curve of heat source equipment is almost the same with each case of OA equipment.

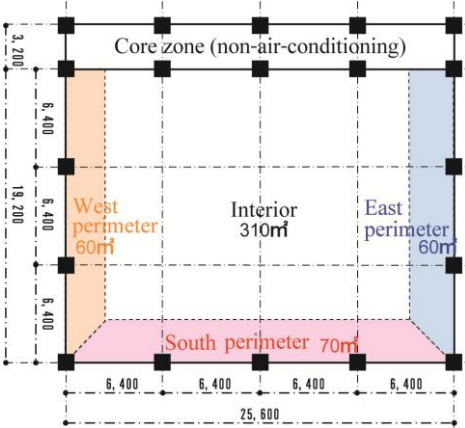

Figure2. A plan of typical floor

Table 4. Specific of members of wall

	Outer wall	Inside wall	Floor • Ceiling	Window glass
member of frame-work	ALC 100mm rock wool (air space) aluminum 1mm	plaster board 8mm plaster board 8mm (air space) plaster board 8mm plaster board 8mm	carpet iron (air space) concrete 150mm (air space) coustic board 10mm	double glazing 6mm+6mm
Heat penetration	0.65 W/m ² K	2.03 W/m ² K	1.4 W/m ² K	3.29 W/m ² K
PAL	267MJ/m ² • year			(SC 0.52)

Table 5. Condition of indoor environmental

	Summer (June~September)	Winter (December~March)	between periods (April/May/October/ November)
Room condition	26°C 50%	22°C 40%	No air conditioning
Air conditioning running time	Pre cooling 8:00~ 9:00 Running 9:00~18:00	Pre heating 8:00~ 9:00 Running 9:00~18:00	No air conditioning

Table 6. Condition of internal heat

Lighting	Person staying in the room	The air outside
20 W/m ²	0.2 人/m ²	25m ³ /h•man

Table 7. Equipments list(OA equipment heat generation 40W/m²)

	application	Specification	umber
primary side of aircondition	air-cooled heat pump	cooling power:212kW electric power consumption:75.8kW volume of cold water:608L/min (7-12°C) heating power:236kW electric power consumption:79.4kW volume of heat water:677L/min (45-50°C)	2
	tiller unit air-cooled)	cooling power:265kW electric power consumption:94.5kW volume of cold water:760L/min (7-12°C)	2
	cold and heat water cold water primary	single-suction volute pump:677L/min×350kPa×7.5kW single-suction volute pump:760 L/min×350kPa×11kW	2 2
secondary side of airconditioning	AHU (interior)	face area:0.748m ² number of line:6 number of tube : 24/one line volume of outside air:2,500m ³ /h air supply fan:7,430m ³ /h×500Pa× cooling power:57.7kW volume of water:166L/min(7-12°C) heating power:24.3kW volume of water:70L/min(45-40°C)	10
	FCU1 (south perimetor)	volume of ventilation:420m ³ /h electric power consumption:0.048kW cooling power:2.0kW volume of water:5.8L/min(7-12°C) heating power:1.7kW volume of water:4.9L/min(45-40°C)	40
	FCU2 (west perimetor)	volume of ventilation:1120m ³ /h electric power cooling power:5.6kW volume of water:16.1L/min(7-12°C) heating power:1.9kW volume of water:5.5L/min(45-40°C)	30
	FCU3 (east perimetor)	volume of ventilation:1120m ³ /h electric power cooling power:5.3kW volume of water:15.2L/min(7-12°C) heating power:1.9kW volume of water:5.5L/min(45-40°C)	30

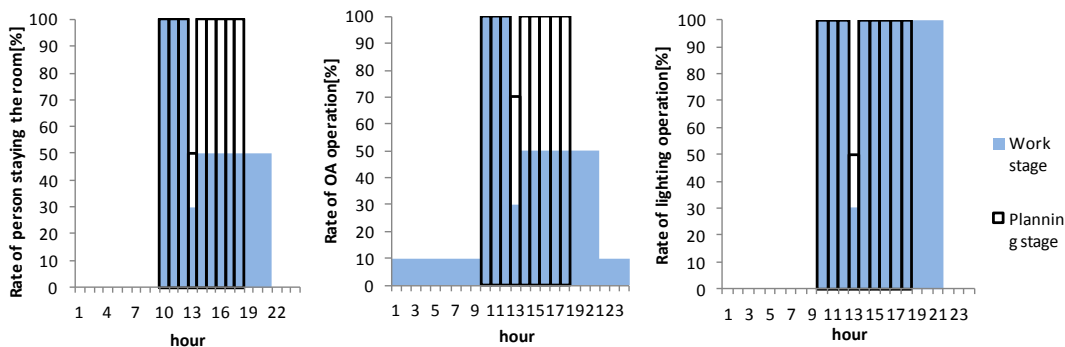

Figure 3. Schedule of internal heat use operation

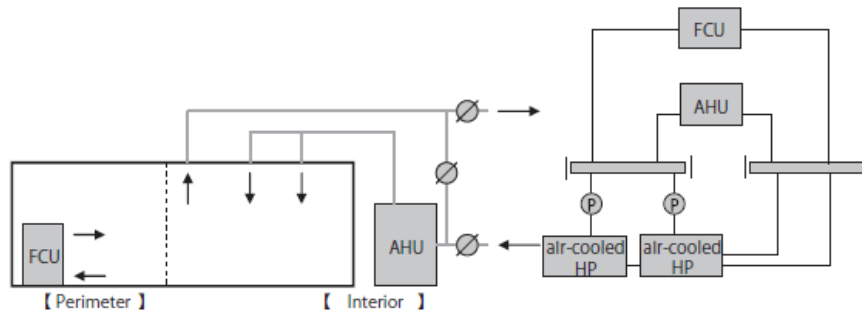

Figure4. System diagram

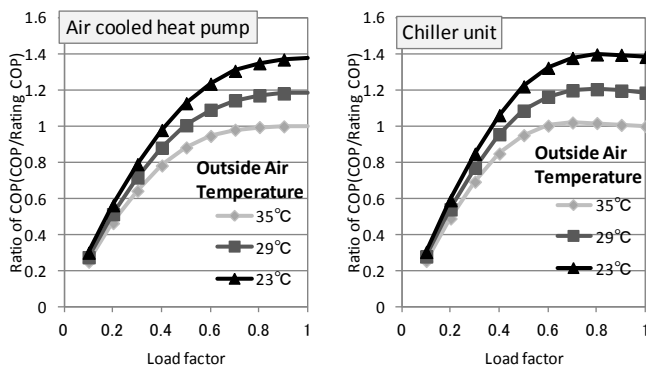

Figure5. Performance curves of heat source

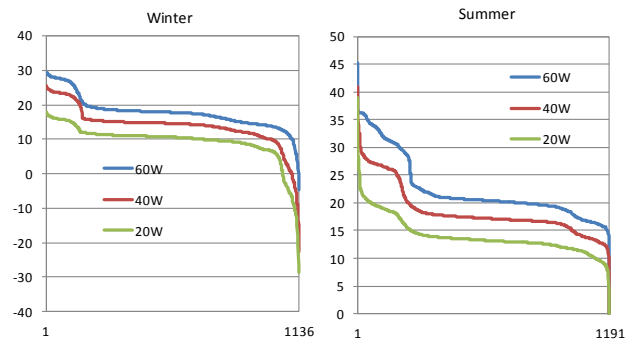

Figure6. Thermal load (only interior zone)

4. Result of energy saving techniques

4.1 Heat load factor and application effect comparison

Figure 7 shows the results of annual heat load calculation in each case, and it shows only internal heat load for interior zone. System simulation results are shown from figure 7 to figure 10. Each result of energy saving effect shows with the standard case ratio of primary energy consumption to each energy saving technique case.

In the case of OA equipment heat density for 40W/m², it shown in figure 7, annual energy consumption of standard case consists of heat source's consumption of 84.5%, air transit system of 13.9% and water-transit system of 1.6%. The biggest case of energy saving effect is Case1 Optimization for intake outside air volume. Case1's amount of energy saving effect is 13.4% comparing with the standard case. Also, Amount of energy saving effect in Case 6 is 11.4%, while in Case2 is 10.3%.

Comparing figure 7 and figure 8, energy saving effect by using the control outside air volume (Case1 and Case2)—in the case of OA equipment heat density of 20W/m² made up the reduction of primary energy consumption, the reduction ratio is 21.4% and 18.5% respectively, and the reduction ratio is larger than in the case of OA equipment heat density of 40W/m². Furthermore, the reduction ratio of Case4 adopted VAV control and Case 7 adopted prevent short-circuit effect become lower in the case of OA equipment heat density of 20W/m².

Comparing figure 7 and figure 9, energy saving effect in Case1 and Case2 for OA equipment heat density of 60W/m², the reduction ratio of primary energy consumption is 9.4% and 6.6%,

and is smaller than in the case of OA equipment heat density of $40\text{W}/\text{m}^2$. Case4 adopted VAV control and Case6 adopted prevent short-circuit effect, Thus, decrease in the case of OA equipment heat density of $60\text{W}/\text{m}^2$.

If internal heat density becomes higher, proportion of energy for air transit system and heat source equipment become larger, and energy-saving effect by adapted VAV control to become large. Also, as the internal heat density become higher, the amount of effect by adapted measures related to controlling outside air volume (Case1 and Case2) decrease, because the internal heat density became higher and thermal load of heat source in room increase so outdoor air load become lower as shown in Figure 6.

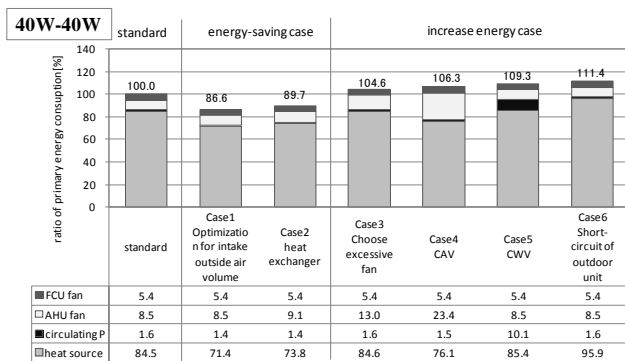

Figure7. Internal heat density $40\text{W}/\text{m}^2 \cdot 100\%$

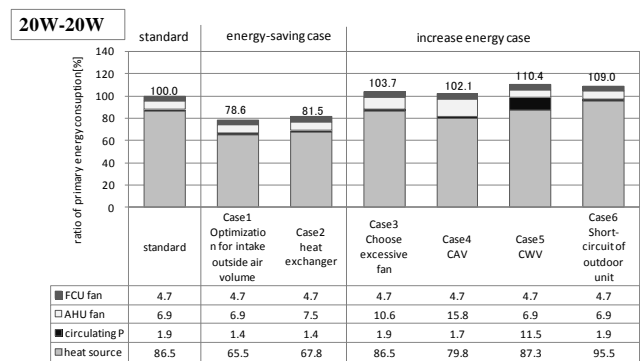

Figure8. Internal heat density $20\text{W}/\text{m}^2 \cdot 100\%$

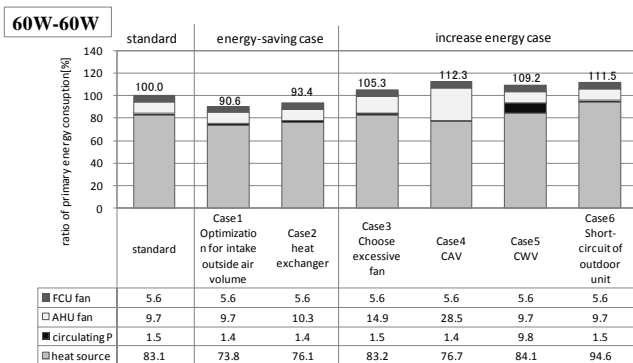

Figure9. Internal heat density $60\text{W}/\text{m}^2 \cdot 100\%$

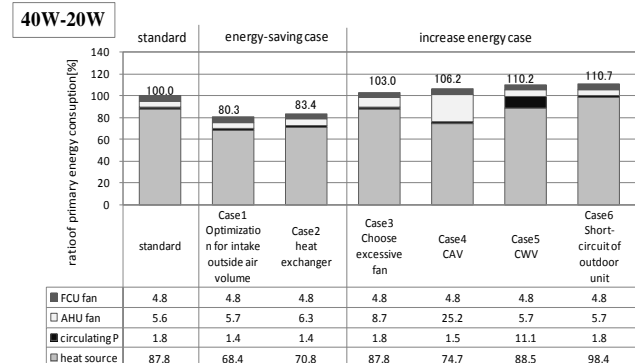

Figure 10. Internal heat density $40\text{W}/\text{m}^2 \cdot 50\%$

4.2 Operating factor (OA equipment availability factor) and application effect comparison

Comparing figure 7 and figure 10, which of the usage rate of OA equipment is 50%, the reduction ratio of primary energy consumption is 19.7% and 16.6% respectively. This is due to the proportion of outdoor air load to internal heat load, the proportion of OA equipment become larger since the outdoor air load was reduced.

Hence, expecting reduction of internal heat density for energy saving electricity is prospective, energy saving techniques which are concerned on outdoor air load reduction..

4.3 Peak electric power consumption

Table 8 shows peak electric power consumption. The electric power consumption reached

peak on 8th August at 10:00 am. The largest effect of reducing peak electric power consumption occurred in Case6, followed in order by Case5, Case3 and Case4.

In the case that OA equipment heat density is 40W/m² and usage rate is 50%, electric power consumption reduced by 20% from the case of usage rate is 100%. Moreover, the electric power consumption is the highest, when short-circuit couldn't be prevented. Since heat source energy takes up high percentage in air conditioning energy and input of heat source is larger. Hence, reducing OA equipment heat density and applying energy-saving techniques is effective for keeping lid on peak electric power consumption.

Table8. peak electric power consumption

Peak electricity (kWh)	20W/m ²	40W/m ² (50%)	40W/m ² (100%)	60W/m ²
standard	228.6	219.7	278.2	318.0
Case1	201.9	192.7	250.7	291.6
Case2	202.5	196.1	251.4	292.2
Case3	235.2	230.7	288.4	328.7
Case4	228.7	228.5	279.2	321.4
Case5	247.2	246.0	299.9	344.5
Case6	259.6	266.3	318.9	362.2

5.Results

In this study, we evaluated the effects of energy saving techniques for typical office buildings on different thermal load factor and operating factor.

The case studies showed that, if internal heat density becomes higher, the amount of energy-saving effects by the controlling outside air volume tends to become small, because the internal heat density became higher and thermal load of room increase so the ratio of outdoor air load become lower. And if internal heat density becomes higher, the amount of energy-saving effects by the VAV control become large. And if the usage rate of OA equipment becomes lower, effect by controlling outside air volume tend to become large.

As for peak electric power consumption, the largest effect of reducing peak electric power consumption is preventing short- circuit of outdoor unit, followed in order by adaptation VAV control and choosing suitable fan. And it is found that reducing heat density of OA equipment and applying energy-saving techniques is effective for keeping lid on peak electric power consumption.

REFERENCES

- The Society of Heating, Air-Conditioning and Sanitary Engineers of Japan. 2009. SHASE guideline for energy efficient. Non-residential buildings.
- Sakai Y et al. 2011. Quantitative evaluation by using system simulation on effect of introducing energy saving technique, AIJ Journal of Technology and Design Vol.17, No.37, pp 943-948