

Modelling, testing and optimization of a MVHR combined with a small-scale speed controlled exhaust air heat pump

Fabian Ochs – University of Innsbruck, Austria – Fabian.Ochs@uibk.ac.at

Dietmar Siegele – University of Innsbruck, Austria – Dietmar.Siegele@uibk.ac.at

Georgios Dermentzis – University of Innsbruck, Austria – Georgios.Dermentzis@uibk.ac.at

Wolfgang Feist – University of Innsbruck, Austria; PHI, Germany – Wolfgang.Feist@googlemail.com

Abstract

A micro-heat pump in combination with a mechanical ventilation with heat recovery (MVHR) unit is developed and integrated in the façade in the framework of the iNSPiRe project. The heat pump uses the exhaust air of the MVHR unit as a source and provides heat to the supply air of the ventilation system. Thus, one compact unit can be used for combined ventilation and heating (and/or cooling). Fresh outdoor air flows into the MVHR unit, where it is heated with a heat recovery efficiency of up to 90%. It is then further heated by the micro-heat pump up to a maximum of 52 °C in order to supply space heating (reverse operation for cooling possible in future versions). A simulation study has been performed to investigate the energy performance of the micro-heat pump. A detailed physical model of the μ HP is developed within the Matlab simulation environment and validated against measurements of two functional models in so-called PASSYS test cells. The performance of the system is investigated for different renovation standards (EnerPHit with 25 kWh/(m²·a) and PH with 15 kWh/(m²·a)) at 7 different climatic conditions.

1. Introduction

The majority of existing building stock in Europe and worldwide is poor energy performance buildings and renovation plays a major role in achieving climate protection and energy independence. Deep renovation solutions in combination with integrated HVAC systems are developed within the framework of the iNSPiRe European project. In this work the development, testing and modelling of a façade integrated micro-heat pump (μ HP) in combination with mechanical ventilation with heat recovery (MVHR) is

presented. Different functional models are developed in the framework of the iNSPiRe EU-project and are measured in PASSYS test cells (Passive Solar Systems and Component Testing) at the laboratory of Innsbruck University and will be later monitored in a demo building in Ludwigsburg, Germany. It is an example of social housing built in the 1970s, which contains 4 flats on 4 storeys. During the renovation process, a prefabricated timber frame façade will be fitted onto the building. The reliability and durability of the unit will be tested and the components and the system including control will be optimized.

2. Motivation and Concept

The main objective of the development of a façade integrated micro-heat pump (μ HP) is a cost-effective mechanical ventilation system with heat recovery (MVHR) in combination with a vapour compression cycle for heating/cooling (μ HP) for the application in very energy efficient buildings with a specific heating load in the range of 10 W/m². The exhaust air of the MVHR is the source of the micro-heat pump with a heating power of approx. 1 kW, which heats the supply air to max. 52 °C. A pre-heater (defroster) and backup heater for peak load coverage are required. For comfort reasons, an additional bathroom radiator is recommended.

The prefabricated unit is designed as a compact system for façade integration and thus minimal space use. With this compact mechanical ventilation heating (and cooling) system, cold ducts inside the thermal envelope can be avoided.

As the whole solution will be prefabricated, the construction and installation time can be kept as short as possible. A minimal installation effort is desirable for economic reasons. With the micro-heat pump, renovations with minimum intervention are enabled (minimum invasive renovation). A simplified hydraulic concept is shown in Figure 1.

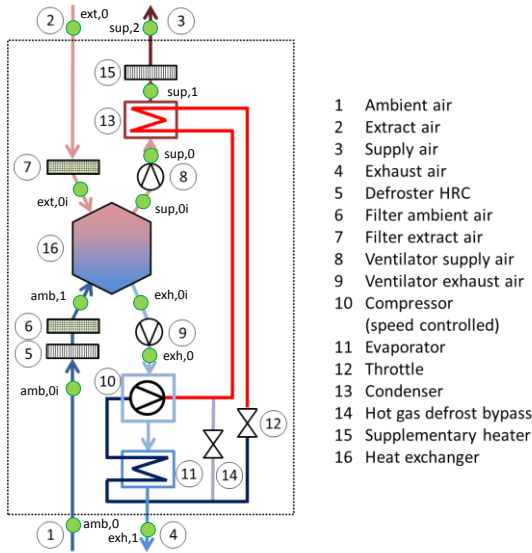

Fig. 1 – Hydraulic scheme of the micro-heat pump

The ambient air (1) will be heated with the defroster (5) if the ambient temperature drops below -3 °C (optionally -5 °C). The filter for the ambient air (6) is situated in front of the heat exchanger (16). The ventilator for the supply air (8) is situated after the heat exchanger. The supply air will be heated in the condenser (13) of the micro-heat pump. If the temperature of the supply air after the condenser is too low to cover the heat load, a supplementary heater (15) will heat the supply air (3) up to 52 °C. The extracted air (2) of the room is filtered (7) before the heat exchanger. After the heat exchanger, the ventilator for the exhaust air (9) is situated. The compressor of the heat pump is situated in the air flow of the exhaust air in front of the evaporator (11). This is changed to the ambient air in the most recent version. The expansion valve (12) reduces the pressure between condenser and evaporator. Hot gas defrost (14) is necessary in case of ice formation in the evaporator.

3. Thermodynamic Analysis

The MVHR, the vapour cycle and the air heating/cooling are modelled in steady state with Matlab using the CoolProp functions [CoolProp2014] to derive the thermodynamic states of the refrigerant and of the air.

3.1 MVHR

The enthalpy balance (eq. 1) of the heat exchanger (excluding the ventilators) includes thermal losses to the ambient and gains from the room, respectively:

$$H_{ext} - \min(H_{exh,0,i}; H_{exh,0,i,s}) = H_{sup,0,i} - H_{amb,1} - \dot{Q}_{loss,MVHR} \quad (1)$$

The effective heat transfer capability UA_{eff} can be calculated based on the effectiveness of the MVHR η_{PHI} acc. to the definition of Passive House Institute (PHI)

$$\eta_{PHI} = \frac{(\vartheta_{ext} - \vartheta_{exh,0}) + \frac{P_{el,vent}}{\dot{m} \cdot c_p}}{(\vartheta_{ext} - \vartheta_{amb,1})} \quad (2)$$

which is measured for conditions that exclude the occurrence of condensate. The effectiveness is published for many products, see Feist (2014). The effective heat transfer capability is assumed to be constant for all operation conditions (as there is always laminar flow) except for the case when condensation occurs, see Siegele (2014). The actual heat transferred from the warm to the cold stream depends on the flow rate as well as on the ambient and extract air conditions (temperature and rel. humidity) and can then be calculated by

$$\dot{Q}_{MVHR} = UA_{eff} \cdot \Delta\vartheta_{log} \quad (3)$$

with the logarithmic temperature difference

$$\Delta\vartheta_{log} = \frac{(\vartheta_{ext,1} - \vartheta_{sup,0,i}) - (\vartheta_{exh,0,i} - \vartheta_{amb,1,i})}{\ln\left(\frac{(\vartheta_{ext,1} - \vartheta_{sup,0,i})}{(\vartheta_{exh,0,i} - \vartheta_{amb,1,i})}\right)} \quad (4)$$

Here, the power of the ventilators $P_{el,vent}$ has to be considered:

$$\vartheta_{sup,0,i} = \vartheta_{sup,0} - \frac{P_{el,vent}}{2 \cdot \dot{m} \cdot c_p} \quad (5)$$

$$\vartheta_{exh,0,i} = \vartheta_{exh,0} - \frac{P_{el,vent}}{2 \cdot \dot{m} \cdot c_p} \quad (6)$$

where the index i is used for the temperatures inside the MVHR (i.e. before each ventilator). Note that the condensation is accounted for with the effective heat transfer capability (which is a

function of the extract air humidity ratio and the ambient temperature) and therefore the approach must be considered as non-physical. For a physical approach, a discrete MVHR model has also been developed and used for comparison. The discrete model is significantly more time consuming.

For the performance of the MVHR the pre-heater power

$$\dot{Q}_{preheater} = \dot{m}_a \cdot (h_{amb,1} - h_{amb,0}) \quad (7)$$

has to be considered. The COP of the MVHR can then be calculated as follows

$$COP_{MVHR} = \frac{\dot{Q}_{preheater} + \dot{Q}_{MVHR}}{\dot{Q}_{preheater} + P_{divert}} \quad (8)$$

3.2 Vapor Cycle

A simplified physical vapour cycle model for the HP is used to perform a sensitivity analysis and to optimize the components. Pressure losses in and between the components are disregarded with the exception of the pressure loss in the condenser which is considered by a given pressure difference Δp_{cond} . Subcooling and superheating are considered in a simplified way with given temperature differences ΔT_{sub} and ΔT_{super} , respectively (Fig. 2).

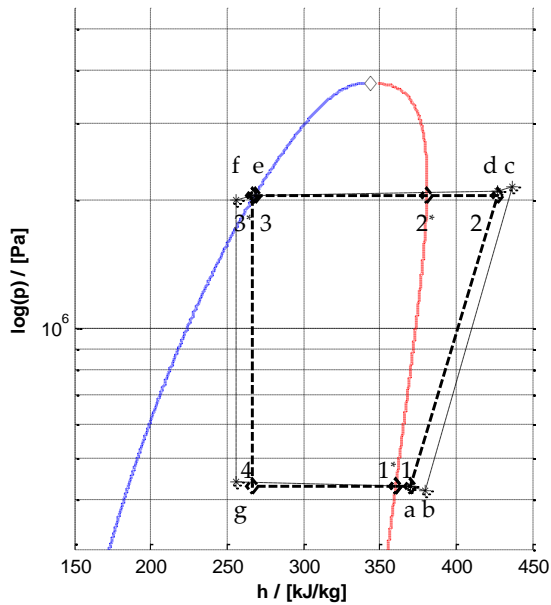

Fig. 2 – Pressure vs. enthalpy diagram of the heat pump cycle, Heat Pump Cycle (thin dashed line): a) evaporator outlet, b) compressor inlet, c) compressor outlet, d) condenser inlet, e) condenser outlet, f) expansion valve inlet, g) evaporator inlet Simplified heat pump cycle (thick dashed line): 1) superheated vapor, 2) condenser inlet, 2*) saturated vapor at p_{cond} , 3*) boiling liquid at p_{cond} , 3) sub-cooled vapor, 4) evaporator inlet, 1*) saturated vapor at p_{evap}

The evaporator is divided in three sections (film evaporation, evaporation and superheating) with varying shares of the total evaporator area A_{evap} , which is 4 m² in the functional model. The heat transfer coefficients are assumed to be constant in each section. Correspondingly, the condenser is divided in de-super-heating, condensation and sub-cooling sections, again with varying shares of the total condenser area A_{cond} and constant (i.e. given) heat transfer coefficients. The section areas of evaporator and condenser are determined iteratively.

The mass flow of the refrigerant

$$\dot{m}_{ref} = D \frac{N_{min}}{60 \text{ s/min}} \cdot \rho_{suc} \cdot \eta_{vol} \quad (9)$$

is a function of the displacement which is here $D = 6.2 \text{ cm}^3$ (Embraco, hermetic reciprocating compressor, speed controlled) and of the volumetric efficiency which is approximated by the following equation

$$\eta_{vol} = 1 - V_c \cdot \left(\tau^{\frac{\kappa}{\kappa-1}} - 1 \right) \quad (10)$$

Here, V_c is the clearance volume fraction, which is a function of the compression ratio and the compressor speed and has to be determined from compressor data. For sake of simplicity instead of the polytropic exponent n , the isentropic exponent

$$\kappa = \frac{c_p}{c_v} \quad (11)$$

is used. The compression ratio

$$\tau = \frac{p_{dis}}{p_{suc}} \quad (12)$$

is a function of the compressor discharge p_{dis} and suction p_{suc} pressure and determines the isentropic efficiency, which can be approximated by a polynomial or implemented by means of a 2D-lookup table.

The electrical efficiency of the inverter depends on the speed of the compressor and can be approximated with the following polynomial

$$\eta_{el,inv} = (-1.09 \cdot 10^{-7} \cdot (N/RPM)^2 + 0.0009 \cdot (N/RPM) - 1.034) \% \quad (13)$$

Finally, the performance of the heat pump

$$COP_{HP} = \frac{\dot{Q}_{cond}}{P_{compressor}} \quad (14)$$

and the system performance can be calculated

$$COP_{sys} = \frac{\dot{Q}_{preheater} + \dot{Q}_{MVHR} + \dot{Q}_{cond} + \dot{Q}_{postheater}}{\dot{Q}_{preheater} + P_{divert} + P_{d,HP} + \dot{Q}_{postheater}} \quad (15)$$

Here, the electric consumption of the heat pump is

$$P_{el,HP} = \frac{P_{el,comp}}{\eta_{HP}} \quad (16)$$

The post-heater power is included

$$\dot{Q}_{postheater} = \dot{m}_a \cdot (h_{sup,2} - h_{sup,1}) \quad (17)$$

For the post-heater either a given temperature e.g. $\theta_{sup,2} = 52 \text{ }^\circ\text{C}$ is assumed or alternatively the power of the post-heater is calculated given a constant required total heating power which is

$$\dot{Q}_{tot} = \dot{m}_a \cdot (h_{sup,2} - h_{amb,0}) \quad (18)$$

4. Simulation Results and Sensitivity Study

4.1 Reference Case

The performance of the micro heat pump is a function of the following boundary conditions:

- Speed of the compressor (rounds per minute, rpm) (high influence)
- Volume flow (high influence)
- Ambient temperature (small influence)
- Room temperature (small influence)
- Room humidity (very small influence)

The resulting temperature vs. humidity ratio diagram is shown in Fig. 3.

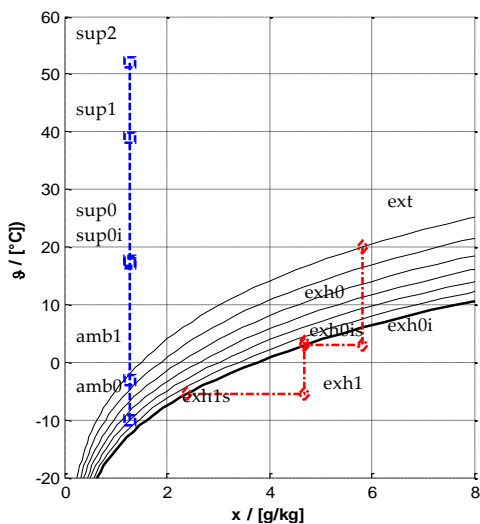

Fig. 3 – Temperature vs. humidity ratio diagram

Taking a flow rate of $90 \text{ m}^3/\text{h}$ and maximum compressor speed (4500 rpm) as an example, for

the boundary conditions of $-10 \text{ }^\circ\text{C}$ and $-5 \text{ }^\circ\text{C}$ ambient temperature and $20 \text{ }^\circ\text{C}$ extract air temperature with a relative humidity of 35% and the parameters mentioned in table 2 below the following results are obtained:

Table 1 – Performance of the μHP

Parameter	-10 $^\circ\text{C}$	-5 $^\circ\text{C}$
COP _{sys} w\ post-heat. to 52 $^\circ\text{C}$	1.93	2.15
COP _{sys} = 2.56 w\ o post-heat.	2.07	2.31
COP _{HP}	1.54	1.53
\dot{Q}_{tot} / [W]	1594.2	1448.5
$\dot{Q}_{pre-heating}$ / [W]	179.9	51.3
\dot{Q}_{cond} / [W]	766.3	763.6
\dot{Q}_{MVHR} / [W]	539.9	548.5
$\dot{Q}_{post-heating}$ / [W]	108.1	85.0
\dot{m}_{MVHR} / [g/h]	50.2	56.0
$\dot{m}_{condensat}$ / [g/h]	194.8	192.3

The pre-heater is assumed to work ideally, here (pre-heating to $-3 \text{ }^\circ\text{C}$). Due to the cyclically required deicing of the evaporator the system COP decreases from 2.31 to 1.88 at $-5 \text{ }^\circ\text{C}$. The deicing control offers potential for optimization.

The parameters used for the simulation correspond to the design of the first functional model (see section 5) and are summarized in table 2. An improved version is currently being measured in the lab and better performance can be expected. The aim is a heat pump COP of at least 2, see also section system simulation, below.

Table 2 – Parameter of the MVHR and μHP , see Siegele (2014)

Parameter	Symbol	Value (range)	Unit
Volume flow rate	V	90 (60 ... 150)	m^3/h
Specific ventilation power	$p_{el,vent}$	0.4	Wh/m^3
Heat recovery efficiency (PHI definition)	η_{PHI}	0.85	-
Heat losses of MVHR	$Q_{loss,MVHR}$	0	W
Compressor displacement	D	6.2	cm^3
Clearance	V_c	0.0375	-
Volume fraction			
Compressor frequency	N_{min}	2000 (1000 ...	rpm

Refrigerant	-	4000)	-
		R290	
		(R134a)	
Heat loss compressor	$Q_{loss,comp}$	0	W
Electrical efficiency of compressor	η_{comp}	0.85	-
Area of evaporator	A_{evap}	4	m^2
Heat transfer coefficient of evaporator	U_{film}	20	$W/(m^2 K)$
	U_{evap}	6	
	U_{super}	6	
Area of condenser	A_{evap}	3	m^2
Heat transfer coefficient of condenser	$U_{desuper}$	10	$W/(m^2 K)$
	U_{cond}	3	
	U_{sub}	3	
Superheating	ΔT_{super}	5	K
Subcooling	ΔT_{sub}	1	K

4.2 Sensitivity Analysis

The ambient conditions have no significant influence on the COP of the heat pump (if a constant i.e. given compressor speed is assumed). However, they have significant influence on the defrosting (i.e. pre-heating), backup (i.e. post-heating) and the deicing demand and thus on the system COP. The compressor frequency (i.e. compressor power) and the volume flow influence the COP and COP_{sys} most, see Fig. 4 for the sensitivity of various parameters.

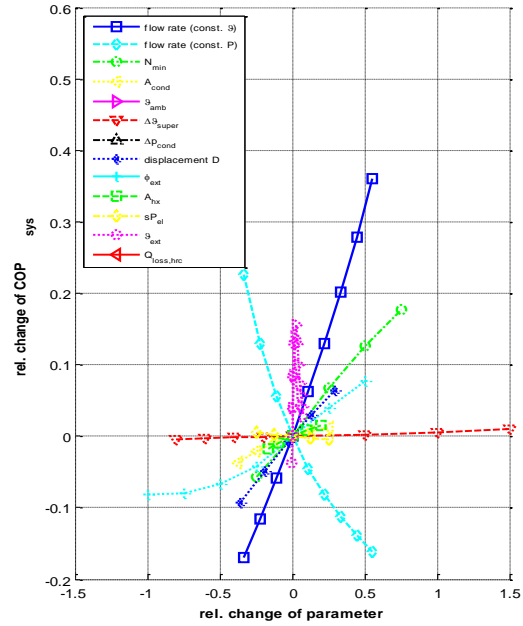
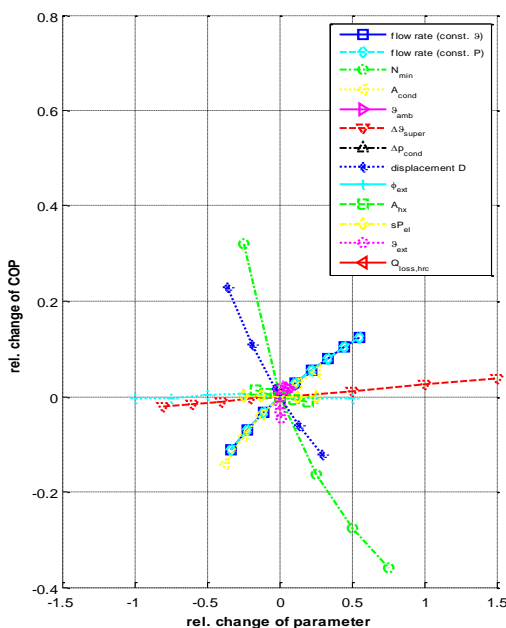

Fig. 4 – Relative change of COP and of system COP vs. relative change of various parameters

5. Functional Model, Measurements and Validation System simulations

5.1 Performance measurements

Different functional models of façades with an integrated mechanical ventilation system with heat recovery are developed in the framework of the iNSPiRe EU-project and are measured in PASSYS test cells (Passive Solar Systems and Component Testing) at the laboratory of Innsbruck University.

The investigation of constructional and building physics aspects was in the focus of the development of the first functional model of a façade with integrated MVHR. Furthermore, practical aspects such as accessibility (maintenance, repair, filter change) have been addressed. A second functional model - the micro-heat pump in combination with MVHR unit - is developed and integrated in a timber frame façade and tested in the second PASSYS test cell. The second functional model is primarily designed to measure the performance of the MVHR unit and of the micro-heat pump and to validate the simulation model. It was therefore built in a façade without a window. The second functional model was optimized based on experimental and simulation results and is currently being tested.

A third functional model will be installed in the acoustic test rig for sound measurements.

Figure 5 shows both functional models installed in COP_{sys} the PASSSYS test cells at UIBK.



Fig. 5 – PASSSYS test cell at UIBK with installed functional models, left cell: 1st functional model (MVHR next to window), right cell: 2nd functional model (μ HP and MVHR) – photo: UIBK

To achieve better agreement between simulation and measurement instead of a constant UA-value, a calibrated function is used. The effective UA-value is decreasing for higher relative humidity due to condensation inside the heat exchanger. For boundary conditions without condensate, the effective UA-value can be assumed to be constant. The effective UA-value drops to 50% in case of high amounts of condensate; see Siegele (2014) for details.

5.2 Validation of the Simulation Model

The measured and simulated coefficient of performance of the system is displayed in Fig. 6 as a function of the ambient temperature with the speed of the compressor as parameter. The simulation model slightly overestimates the COP_{sys} for lower ambient temperatures and underestimates in case of higher ambient temperatures. Overall, relatively good agreement can be achieved; see Siegele (2014) for more details.

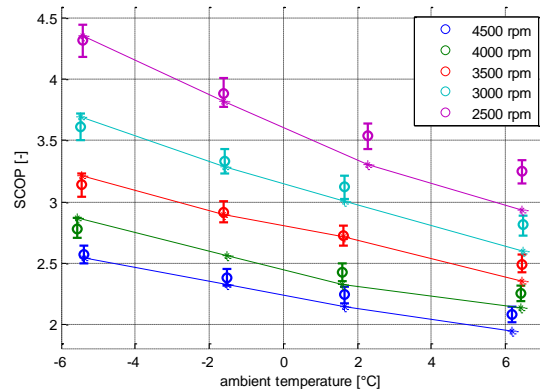

Fig. 6 – Simulated and measured system COP as a function of the ambient temperature with the compressor speed as parameter

The COP of the μ HP is, with values below 2, relatively poor. An improved version has been developed (a compressor with higher capacity situated in the supply air before the condenser, refrigerant R134a, condenser area 4 m²) with the aim to obtain a heat pump COP higher than 2 and system COP of at least 3 for 4500 rpm. Measurements are ongoing.

6. System Simulation

The validated physical model is used to generate a performance map of an improved μ HP for system simulations. The heating with the μ HP of a single family house with two levels of heating demand (15 kWh/(m² a) and 25 kWh/(m² a) is simulated in seven European climates (see Dermentzis et al. 2014 for a detailed description). Here, detailed results for the location Stuttgart (Meteonorm) are presented.

6.1 Building Model

The building considered in this study is a semi-detached single-family house, with a tempered floor area of 78 m². It is defined within the iNSPiRe project [iNSPiRe, 2014] as a typical European single-family house construction. The actual building is located in London, UK, and consists of two floors and an unheated attic, with an insulated ceiling between the top floor and the attic [Gustafsson, et al., 2014]. The ventilation rate is taken to be 0.4 h⁻¹ and the infiltration rate 0.1 h⁻¹. Two renovation levels (i.e. U-values of roof, floor,

walls and windows) are defined: EnerPHit (EN) and Passive House standard (PH).

In MATLAB Simulink the complex building model of the Carnot Blockset is used. In this study, only space heating is investigated. Total energy consumption includes heat pump compressor, backup heater, defroster of heat recovery and ventilator fans. Thus, all energy consumed is electricity.

6.2 Influence of the size of the heat pump power and of the control strategy on the performance

A set of dynamic simulations is performed to investigate the influence of the controller. At a first step, sensitivity analysis is performed assuming constant compressor frequency. The on/off controller with hysteresis is used. The different RPM correspond to different heating capacity of the micro-heat pump as shown in Table 3.

Additionally, dynamic simulations are performed using a PI controller parameterized for the frequency-controlled compressor with a range of 2000 to 4500 rpm. In Fig. 7 the total electrical consumption is presented. The results show an improvement of system performance by using a PI controller. The benefit of a PI controller compared to the on/off controller with maximum frequency (4500 RPM) is about 13% for EnerPHit and 20% for PH standard, but only 2 to 3% in case of the optimal dimensioned speed. The main advantage of the speed-controlled compressor might be that the possibilities of an improperly dimensioned heat pump with regard to the building load is reduced.

Table 3 – Heating capacity of micro-heat pump

RPM	P_{hp} / [W]	COP
2000	384	3.84
2500	453	3.33
3000	520	2.96
3500	584	2.68
4000	646	2.40
4500	710	2.11

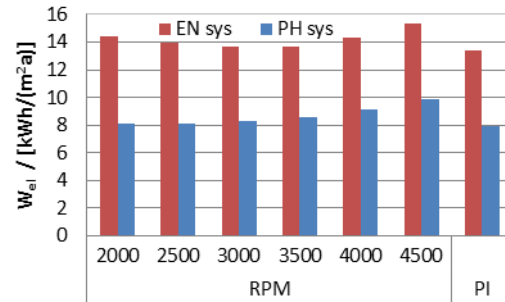

Fig. 7 – Total electrical consumption using PI or on/off controller.

Fig. 8 shows the load duration curve of the building heating load and the load covered by the micro-heat pump. Results are presented for two control strategies: PI controller (continuous line) and on/off controller with constant compressor speed (dotted line) - the optimum speed is chosen (see Fig. 7).

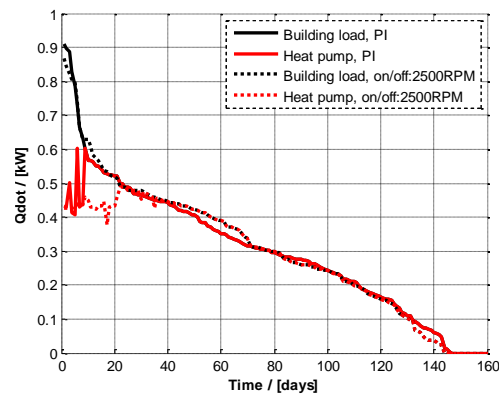

Fig. 8 – Load duration curves of the building and load covered by the micro-heat pump using PI controller and on/off controller (@ 2500 RPM) with the building in PH standard; daily average values

Also with a PI controller, the backup heater is needed for the peak loads. In the case of the on/off controller, the share of the backup heater increases significantly.

7. Outlook & Conclusion

The aim of this work is the development of a μ HP with a MVHR and to establish a cost-effective and reasonably efficient system for ventilation, heating and optional cooling for very efficient buildings such as Passive Houses or buildings renovated to EnerPHit standard. Functional models have been built and are tested in PASSYS test cells. Measurement results are used to validate a new

simplified physical MVHR and heat pump model. The physical model delivers results with relatively good accuracy. The model can be used to assist optimizations and further developments. Simulation is used to show that the performance of the heat pump can be further improved. This is part of ongoing and future developments. Furthermore, the results delivered by the physical model can be used as input for system simulations. Results of simulation studies show that the concept of the μ HP is feasible. The micro-heat pump will be monitored in a demo building in Ludwigsburg. The μ HP represents a cost-effective compact heating system for buildings with very high-energy performance (new buildings as well as for deep renovations) which - integrated in a prefabricated façade - can be applied with minimum space use and reduced construction and installation effort and time.

8. Acknowledgement

These results are part of the research and simulation work of the iNSPiRe European project funded under the 7th Framework Program (Proposal number: 314461, title: Development of Systematic Packages for Deep Energy Renovation of Residential and Tertiary Buildings including Envelope and Systems, duration: 01.10.2012 – 30.09.2016).

9. Nomenclature

Symbols

A	area (m ²)
c_p, c_v	specific heat capacity (J/(kg K))
COP	coefficient of performance
D	displacement (m ³)
H	enthalpy (J)
h	efficiency (-)
κ	isentropic exponent (-)
m	mass flow (kg/s)
N	revolutions (rpm)
n	polytropic exponent (-)
p	pressure (Pa)

P	power (W)
ρ	density (kg/m ³)
ϑ	temperature (°C)
sP	specific power (Wh/m ³)
T	temperature (K)
τ	compression ratio (-)
U	overall heat transfer coefficient
V	Volume (m ³)

Subscripts/Superscripts

a	air (dry air)
amb	ambient
C	Clearance
comp	compressor
cond	condenser
dis	discharge
el	electric
eff	effective
exh	exhaust
ext	extract
evap	evaporator
HP	heat pump
i	inside/internal
inv	inverter
min	minute
MVHR	mech. vent. with heat recovery
ref	refrigerant
s	saturation
suc	suction
sub	sub-cool
super	super-heat
sup	supply
sys	system
tot	total
vent	ventilation
vol	volumetric

References

- CoolProp2014 <http://coolprop.sourceforge.net>, 2014
- Feist, W. (editor), EnerPHit Planerhandbuch - Altbauten mit Passivhaus Komponenten fit für die Zukunft machen. Autoren: Zeno Bastian, Wolfgang Feist 2012.
- Feist W., passiv.de Database of Certified Passive House Components; Building Services; 2014
- Gustafsson M., Dermentzis G., Myhren J.A., Bales C., Ochs F., Holmberg S., Feist W., Energy

performance comparison of three innovative HVAC systems for renovation through dynamic simulation – 2014

Hafner, Bernd. 2012. CARNOT 5.2 Manual. 2012.

The Mathworks, Inc. 2012. Matlab R2012a Help.

iNSPiRe, Proposal number: 314461, title: Development of Systematic Packages for Deep Energy Renovation of Residential and Tertiary Buildings including Envelope and Systems, WP 2, Deliverable 2.1 Report, 2014.

Ochs F., Dermentzis G., Siegele D., Konz A., Feist W., Use of Building Simulation Tools for Renovation Strategies - a renovation case study. Energy Forum, Bressanone 2013.

Ochs F., Dermentzis G., Siegele D., Konz A., Feist W., Façade integrated active components in timber-constructions for renovation - a case study. NSB 2014

Ochs F., Dermentzis G., Siegele D., Feist W., Feasibility of a micro-heat pump - Energy performance simulation, Energy Forum, Bressanone 2014.

Passive House requirements [Online]. - 9 4 2014. -

Passive House Institute (a). PHPP – The energy balance and passive house planning tool. Retrieved 4 9, 2014, from http://passiv.de/en/04_phpp/04_phpp.htm

Siegele D., Measurement and Simulation of the Performance of a Façade-integrated MVHR with Micro Heat Pump, Master Thesis, University of Innsbruck, 2014.