

SIMULATION OF ENERGY-EFFICIENT OFFICE BUILDINGS IN NORWAY

Matthias Haase¹, Igor Sartori¹, Natasa Djuric², and Rasmus Høseggen²

¹ SINTEF Building and Infrastructure, Buildings department, Trondheim, Norway

² NTNU, Institute for Energy and Process Technology, Trondheim, Norway

ABSTRACT

Design of different energy-efficient office buildings in Norway with different energy concepts were studied with a number of different simulation tools. With the help of dynamic computer simulations of energy and indoor environment the impact on energy use and indoor environment was analyzed. A focus was put on a comparison of different simulation tools and their accuracy in predicting the performance in terms of thermal comfort and energy consumption of various cases.

The results show that significant differences in output of the various tools make an objective evaluation difficult. In particular, significant improvements of a standard model description are needed. The importance of a clear simulation and reporting strategy and level of details became obvious. Here, national and international efforts are needed in order to make building regulations more effective and its implementation successful.

INTRODUCTION

The design of energy-efficient buildings in Norway has been in focus for some years now. A lot of work has been done in strengthening the building codes towards a reduction of the use of energy in buildings. Nordic countries like Norway are facing two major challenges. First, new building regulations aim to reduce emissions related to energy consumption in buildings. In heating dominated climates like Norway this implies more stringent building envelope requirements to reduce heat losses during the heating period (Figure 1). Insulation and air tightness of the building envelope ensures this but leads consequently to overheating problems during the summer period. Consequently, especially in buildings with high internal loads like commercial buildings, cooling equipment is needed that uses additional energy (Andresen et al., 2005).

The second challenge is that climate change predictions for Norway forecast an increase in mean temperature and precipitation. This has the potential of increasing the overheating problems in future summer periods and might even extend it to autumn and spring seasons. Especially in western parts of

Norway this may also lead to hot and humid summer periods (Lisø et al., 2003).

While the design of building form and shape is limited by site-specific constraints, the technical equipment of a building in Norway is defined in NS3031 (NS3031, 2007).

OBJECTIVES

With the help of dynamic computer simulations of energy and indoor environment for a building energy concept with night ventilation to avoid mechanical cooling the impact the different parameters on energy use and indoor environment was analyzed. Here, very often simplifying assumptions are chosen which can mislead the designer of a building in the early design stage (Papamichael and Protzen, 1993, Szokolay, 1987). A focus was put on a comparison of different simulation tools and their accuracy in predicting the performance in terms of thermal comfort and energy consumption.

METHODOLOGY

A simple landscape office room as described in Figure 2 was simulated. For assessment purposes, several assumptions have to be made. This includes reference climatic data, occupancy and operation schedules, and a detailed description of the ventilation system, including a heat recovery system (Table 1). Four different simulation tools were used to model and simulate the performance of the building. Here, it was important to try to identify the range of calculated total energy consumption of a building. Main parameters to study were:

- simulation of single zone model with ventilation system with heat recovery system
- Night ventilation strategy with SPF = 2 kW/(m³/s)
- the use of different simulation tools (TRNSYS, esp-r, energyplus, Simien) and its range in calculation results
- comfort criteria and energy issues (thermal comfort vs. heating cooling demand) and its implication for the early design

Table 1
Description of simulation model

Location	Oslo (latitude 59.9°N, longitude 10.6°E), IWEC-data file
Building type:	Office building,
Floor areas :	Total heated floor area = 300 m ²
Dimensions and heights :	25 m x 12 m; floor-to-floor = 3 m ; window height = 2 m ; window-to-wall ratio = 0.53 (S); = 0.55 (W); = 0 (N,E)
Occupancy :	Mon. to Fri.-0700 to 1900 hr, Sat. and Sun. Closed
Constructions of building envelope :	<p>(a) External walls U-value: 0.18 W/m²K (according to TEK 2007 - Energiltak); insulation on the outside, inside exposed concrete</p> <p>(b) Ceiling facing floor (intermediate storey)</p> <p>(c) ceiling 200mm heavyweight concrete, but inner half of ceiling is covered with sound absorbers (i.e. mineral wool 50mm)</p> <p>(d) Floor facing ceiling (intermediate storey)</p> <p>(e) Windows Three panes, 3mm clear glass (1 with Low-e coating) + 13 mm argon [no frame]</p> <p>- U-value: 1.2 W/m²K; glazing factor: 1; g-value: 0.58; visible transmittance: 0.7</p> <p>- Solar shading system: venetian blinds, outside, light color, automatic (closes when radiation on window > 200W/m²)</p>
HVAC design parameters:	<p>(a) Building load</p> <p>-Occupancy density = 0.1 person/m² (seated quite = 108 W/pers (1.0 Met); normal office clothing (1 clo))</p> <p>-Lighting load = 8 W/m² ; equipment load = 11 W/m² (according to TEK 2007)</p> <p>-Infiltration = 0.1 ach (= n50=1.5 according to TEK 2007 - Energiltak)</p> <p>-Heating set point Operative temperature 21°C during operating hours (19°C outside operating hours)</p> <p>-Cooling set point Operative temperature 24°C (off outside operating hours)</p> <p>(b) HVAC (ventilation) system</p> <p>Minimum 7.0 m³/hm²; maximum 12.0 m³/hm²</p> <p>-Throttling range = 0°C (E+ limitation, if you can do better please do so)</p> <p>- operating hours 0600 hr to 2000 hr</p> <p>- HVAC system type = VAV Ventilation</p> <p>- Supply Air Temperature = 19°C Nov-Mar; 18°C Apr-May + Sep-Oct; 17°C Jun-Aug</p> <p>- Heating and Cooling batteries always able to satisfy the load (= no power limits, but OFF at night and weekends)</p> <p>- Night ventilation if Indoor temp > 21°C and outdoor delta-T = 2°C, max 12.0 m³/m²h</p> <p>- SFP = 2 kW/(m³/s) daytime, 1 nighttime; SFP is calculate for nominal Q(70%) = 8.4 m³/m²h; SPP = 0.6 kW/(l/s)</p> <p>(c) Heating</p> <p>- operating hours 0700 hr to 1900 hr (heating OFF from May to September)</p> <p>(d) Cooling</p> <p>- operating hours 0700 hr to 1900 hr</p>

The use of different simulation software

The simulation results in regard of the use of the following software tools were examined.

- trnsys (www.trnsys.com)
- esp-r (www.esru.strath.ac.uk/Programs/ESP-r.htm)
- energyplus (apps1.eere.energy.gov/buildings/energyplus)
- simien (www.programbyggerne.no)

Trnsys offers the possibility to describe a zone and conduct heat balance calculations. At an exterior surface, the longwave radiation and the convective heat exchange are separated and the absorbed solar radiation is accounted for. The transient heat exchange through the surfaces composing a zone has been validated (Voit et al., 1994). A detailed description of the resistance calculation method is available from (Seem, 1987). For external surfaces the long-wave radiation exchange at the outside surface is considered explicitly using a fictive sky temperature, *TSky*, which is an input to the TYPE 56 model and a view factor to the sky, *fsky*, for each external surface.

Esp-r is based on a finite volume, conservation approach in which a problem (specified in terms of geometry, construction, operation, leakage distribution, etc.) is transformed into a set of conservation equations (for energy, mass, momentum, etc.) which are then integrated at successive time-steps in response to climate, occupant and control system influences (ESRU, 2007). ESP-r has been under development for more than 30 years, and has been undergoing numerous validation tests. A summary of all validation tests can be found in Strachan (2000).

Energyplus EnergyPlus is an integrated simulation. This means that all three of the major parts, building, system, and plant, must be solved simultaneously. The solution begins with a zone heat balance that updates the zone conditions and determines the heating/cooling loads at all time steps. This information is fed to the air handling simulation to determine the system response; but that response does not affect zone conditions. It allows to specify internal heat gains comprised in convective, radiant and latent gains. Convective gains are instantaneous additions of heat to the zone air (EnergyPlus 2006). But does not take into calculation the building tightness. This is a reason that there are differences in the results on the heating consumption. To overcome this problem, thermal bridges as subsurface can be added to the external walls. Then by tuning the parameters of these added thermal bridges, heating loads can be adjusted.

Simien is a dynamic building simulation software that has been further developed from SCIAQ incorporating the Norwegian calculation procedures

NS3031 that have recently been revised (NS3031, 2007, Dokka and Dokka, 2004). This method has also been applied in the Norwegian technical requirements TEK07 (TEK, 2007).

Annual energy consumption

Energy consumption of a typical landscape office has been calculated according to Norwegian Standard (NS3031, 2007). The results are divided into several energy budgets for heating, cooling, lighting, ventilation, and equipment. Figure 1 gives the budget according to the Norwegian standard (NS3031, 2007).

Operative temperatures

The simulation results in regard of summer comfort and cooling energy have been examined. TEK07 allows the operative temperature to exceed 26°C a maximum of 50 hours during operation hours. NS-ISO7730 defines the comfort criteria in detail. In addition, NS3031 limits the annual use of ventilation air for cooling to 24 kWh/(m²a) It further suggests to avoid local mechanical cooling.

Table 1 shows the input parameters that were used for simulation. Energy calculations have been done with the software tools as described above.

RESULTS

The results for annual temperatures are shown in Figure 3. Figure 4 shows the operative temperatures of three simulation packages. It can be seen that there is a difference in calculated temperatures. However, the differences are small, showing a good match between the different tools. In simien there is not output available.

Figure 5 shows the different airflows for a typical winter and a typical summer period. It can be seen that esp-r calculates higher temperatures in the winter while eplus and trnsys calculate very similar operative temperatures in this period.

During the summer period the differences are larger, showing a good match between trnsys and esp-r but eplus results are much lower. This indicates that eplus is more effective in its ventilation strategy. In simien there is not output available.

Energy consumption

Figure 6 shows different fan power for the different tools. This was directly calculated from the airflows in Figure 5 and with SPF as specified in Table 1 according to NS3031. As for the airflow results, eplus results are lower than the other two results. In simien there is not output available.

Figure 7 shows the summarized annual energy consumption results of the different tools. It shows that all simulation tools calculate a total energy consumption below the regulations (TEK, 2007). Total energy consumption results range between 106 kWh/(m²a) (eplus) and 150 kWh/(m²a) (trnsys), with

Table 2
Percentage results compared to TEK07

	TEK07 budget	eplus	esp-r	trnsys	simien
1. Room heating, incl. heating coil	54 kWh/(m ² a)	25.6 %	34.1 %	51.9 %	30.9 %
3. Domestic Hot Water	5 kWh/(m ² a)	100.0 %	100.0 %	100.0 %	100.0 %
4. Fans and pumps	22 kWh/(m ² a)	91.9 %	169.2 %	112.0 %	86.8 %
5. Lighting	25 kWh/(m ² a)	100.0 %	100.0 %	100.0 %	100.4 %
6. Equipment	34 kWh/(m ² a)	100.9 %	100.9 %	100.9 %	101.5 %
7. Room cooling, incl. cooling coil	25 kWh/(m ² a)	32.5 %	41.6 %	134.5 %	42.4 %
sum	165 kWh/(m ² a)	64.5 %	79.0 %	91.2 %	67.3 %

simien and esp-r in between (111 kWh/(m²a) and 130 kWh/(m²a) respectively).

Table 2 gives the percentage in comparison to the budget in TEK07. It shows that the results of the sum (total) vary between 9% (trnsys) and 35% (eplus). However, the differences for the different consumption units vary even more. While energy budget for room heating is drastically reduced (between 48 and 75%), the budget for equipment is nearly the same.

As the results before already indicated, does eplus seem to have the most efficient ventilation strategy resulting in very low energy consumption for heating and cooling (with ventilation air).

Operative temperatures

Table 3 shows the summary of overheating temperatures. It confirms that esp-r calculates higher temperatures which results in higher temperatures. The other three software tools results are very similar. All results show that the number of hours with operative temperatures above 26°C is within the allowed values (50h according to (TEK, 2007)).

Table 3
Overheating hours during operation

	eplus	esp-r	trnsys	simien
>26	0	38	0	2
>25	3	401	47	39
>24	543	1809	769	464
>23	1895	3283	1884	1685
>22	2664	4181	2395	2014

CONCLUSION

The results show that significant efforts are needed in order to find a comprehensive way of simulating and reporting input and output differences when using simulation tools. In particular, the prediction of

energy consumption and summer overheating conditions vary over a large range, depending on the tool that has been used.

Simulation results

A more accurate determination of sensitive input design parameter is needed that can help to identify those design parameter that have a large influence on the results. A sensitivity analysis of design parameter can help to develop and build buildings that follow their intention of reduced energy consumption.

The importance of a clear simulation strategy and level of details became obvious. Here, national and international efforts are needed in order to make building regulations more effective and its implementation successful. A strategy for predicting accurately the building performance is an important step towards a more sustainable building stock in Norway.

Also, effective comfort criteria have to be adopted to a changing and enhanced building energy consumption. The design of energy robust, energy efficient, and comfortable buildings depends on building simulation.

Differences in simulation results

This simulation exercise showed that the different tools have different outputs. It is important to follow up on the differences and difficulties which can be summarized in 6 issues:

- One issue is about the internal gains from people, since E+ uses the total value, sensible + latent as an input and then automatically calculates the sensible part (according to the E+ Engineering Reference Manual that explain how internal gains from people are treated). Here, it became obvious that sensible heat gains were much lower than the input value.
- Energy consumption from the pump for precooling was calculated in the same way in all software programs, BUT it was calculated using far too many hours of

operation. If running the ventilation 14h per day, 5 days per week and for 22 weeks, the total number of hours is 1540 (instead of 2920 that was used in the calculations).

- It can be seen that E+ preheating demand is by far the lowest, even though air flow in winter is similar to the others or eventually a bit higher. The heat recovery with constant efficiency of 70% has to be checked.
- Building construction: looking at the T_{op} it seems that E+ is the more stable, as if E+ has more thermal mass. The walls have insulation in the exterior (200mm mineral wool) then concrete (200mm) and then gypsum board facing the interior of the room (19mm). All ceilings consist of 200mm exposed concrete for half of the area, while the other half has the ceiling covered by 50mm mineral wool to represent the sound absorbers. However, floor (other side of the ceiling) is exposed concrete in E+, while trnsys uses linoleum covering.
- On the other hand, at night time E+ T_{op} drops faster, as if it has less thermal mass. This might be due to an error in the outside air mixer that forced to use another object for night ventilation (instead of switching on the real ventilation system). This is a simplified object used in E+ and here the temp rise in the fan is just proportional. It is important to compare the fan delta T at night for all simulation programs.
- When analyzing the cooling coil load were only the sensible loads considered? This would at least make it easier to compare the results.

Further detailed analysis and simulation is necessary to get more confidence in the simulation results. This further analysis might help to explain the differences in results. A validation with measured data from various case studies is on its way. Before this has not been accomplished, it is very difficult to develop design strategies that incorporate these issues. The large number of uncertain input parameter remains however a challenge.

ACKNOWLEDGEMENT

This paper has been written within the ongoing SINTEF strategic institute project "Climate Adapted Buildings". The authors gratefully acknowledge the Research Council of Norway.

REFERENCES

- Andresen, I., Aschehoug, Ø., Bell, Thyholt, M., 2005. Energy-Efficient Intelligent Facades. A state-of-the-Art, in: SINTEF (Ed.). SINTEF Building and Infrastructure, Trondheim.
- Dokka, K. A. and Dokka, T. H. (2004) User Guide SCIAQ version 2.0. *SCIAQ Pro – Simulation of Climate and Indoor Air Quality*.

- EnergyPlus (2006), User manual, <http://apps1.eere.energy.gov/buildings/energyplus/documentation.cfm>
- ESRU (2007), Energy Systems Research Unit, Strathclyde University, Glasgow, UK, ESP-r website: <http://www.esru.strath.ac.uk/>
- Lisø, K.R., Aandahl, G., Eriksen, S., Alfsen, K.H., 2003. Preparing for climate change impacts in Norway's built environment. *Building Research & Information* 31, 200-209.
- NS3031, 2007. Calculation of energy performance of buildings – Method and data. Standard Norge.
- Papamichael, K., Protzen, J.P., 1993. The Limits of Intelligence in Design, Focus Symposium on Computer-Assisted Building Design Systems of the 4th International Symposium on Systems Research, Information and Cybernetics, Baden-Baden, Germany.
- Strachan P. (2000), ESP-r: Summary of Validation Studies, ESRU Technical Report, Glasgow, UK
- Szokolay, S.V., 1987. Thermal design of buildings. RAIA Education Division, Canberra.
- TEK, 2007. Energi – Temaveiledning, in: Statens Bygningstekniske Etat (Ed.). Norsk Byggtjenestes Forlag.
- Voit, P., Lechner, T. & Schuler, M. (1994) Common EC validation procedure for dynamic building simulation programs – application with TRNSYS. *Conference of international simulation societies*. Zurich.

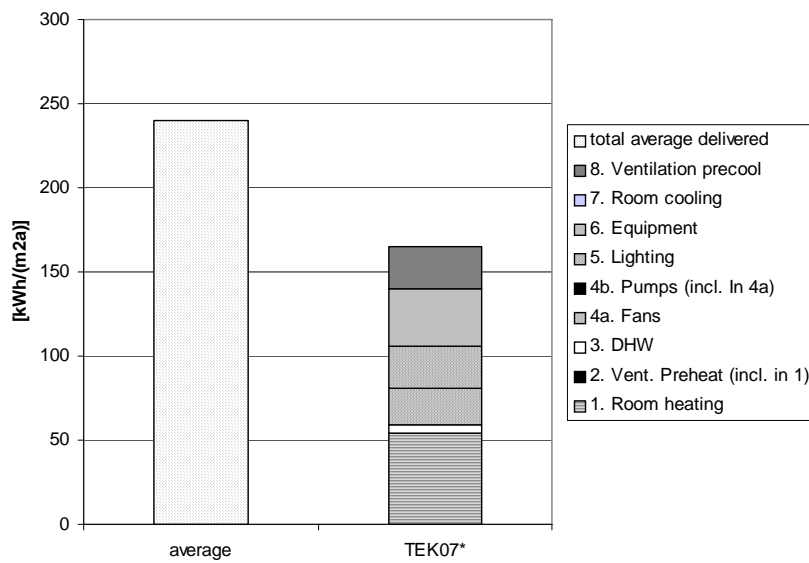

Note *: 4b. fans included in 4a. pumps; 2. Vent. Preheat included in 1. Room heating

Figure 1 Energy consumption in the present building stock (delivered) and according to the new energy targets (netto) (TEK, 2007)

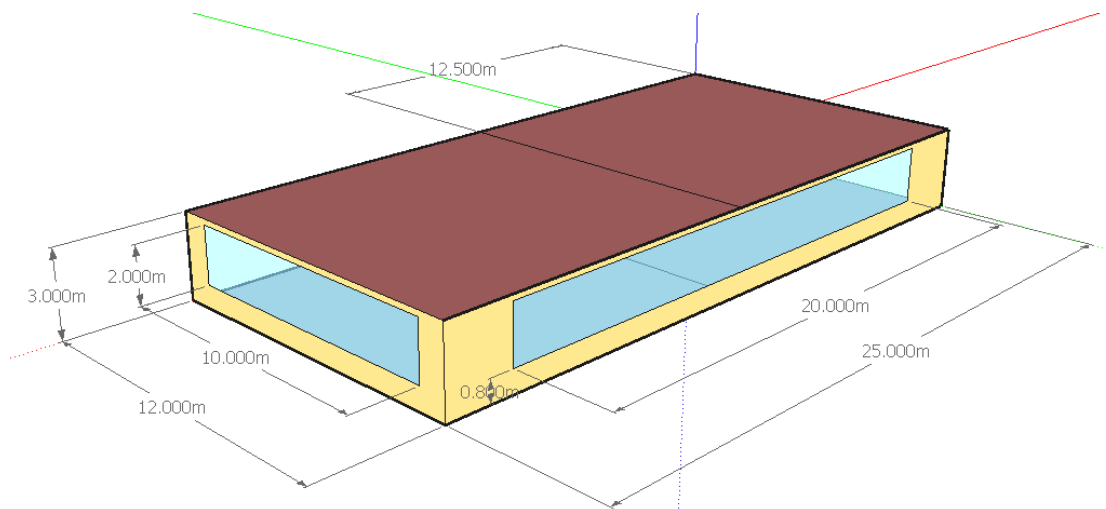

Figure 2 Geometry of landscape office model

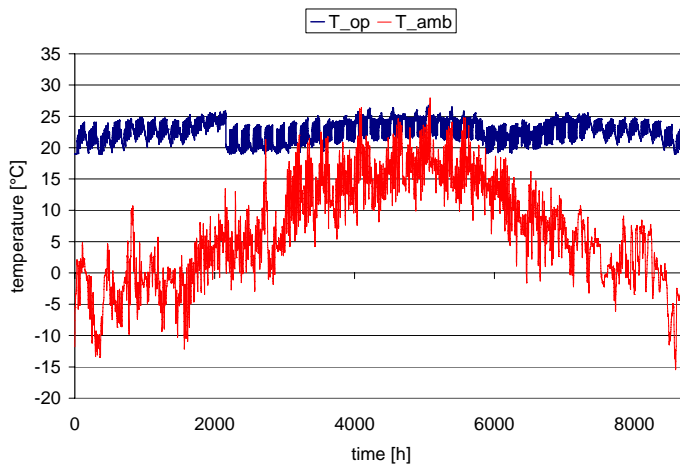

Figure 3 Ambient and operative temperatures

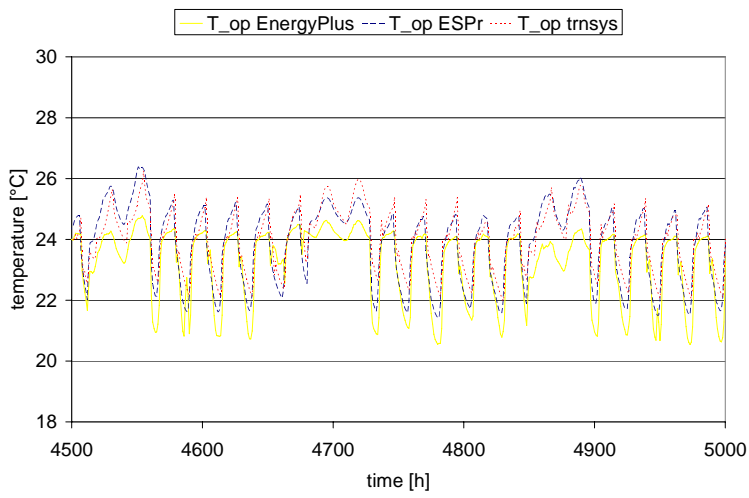
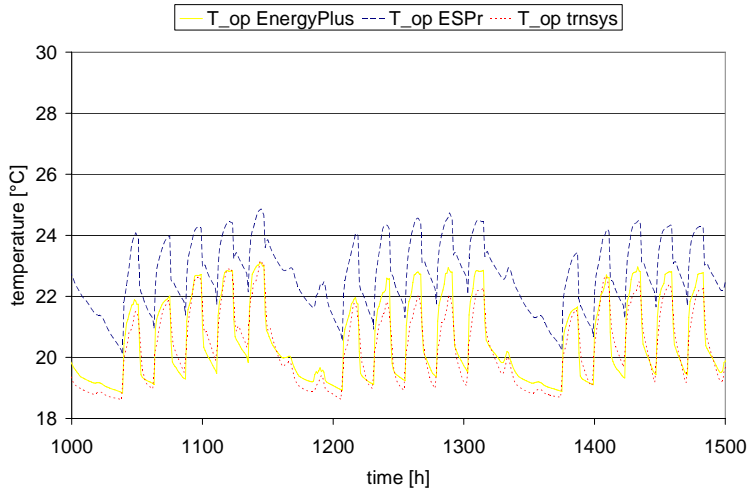

Figure 4 Ambient and operative temperatures for typical winter (above) and summer period (below)

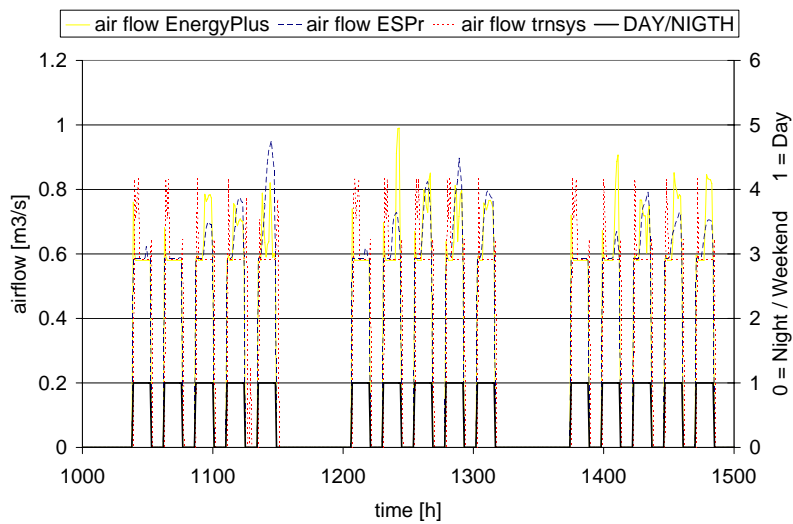

Figure 5a Airflows for typical winter period

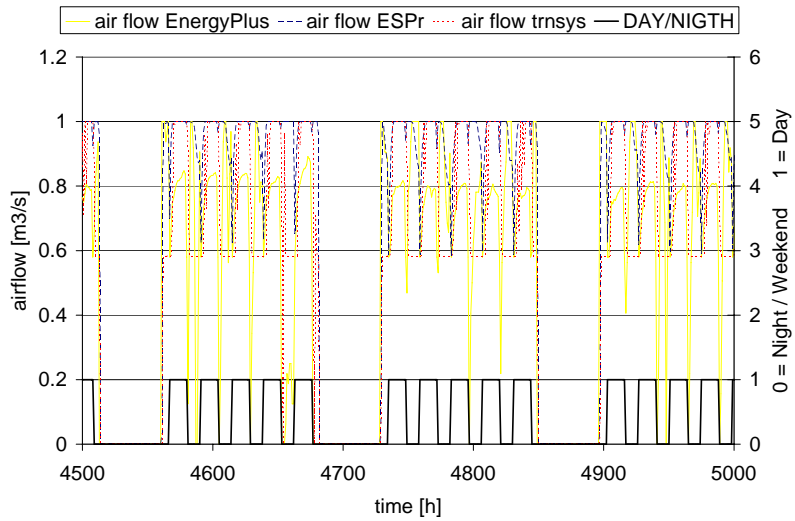

Figure 5b Airflows for typical summer period

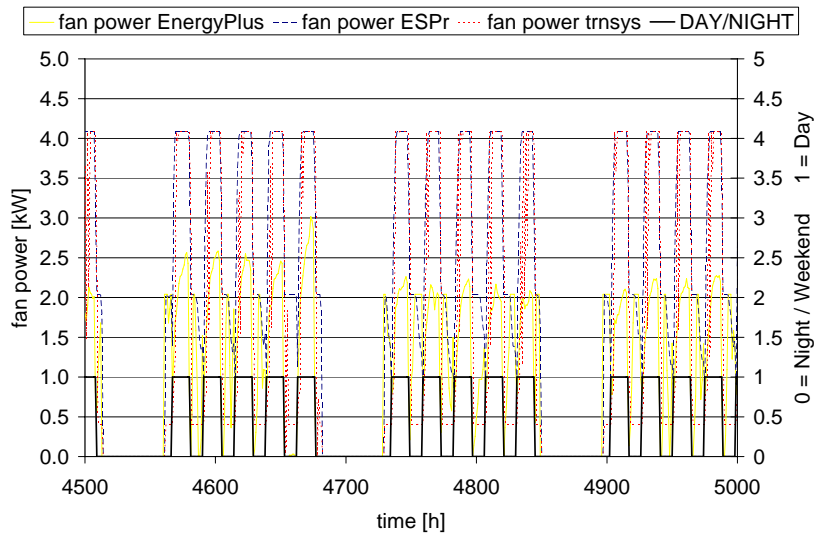
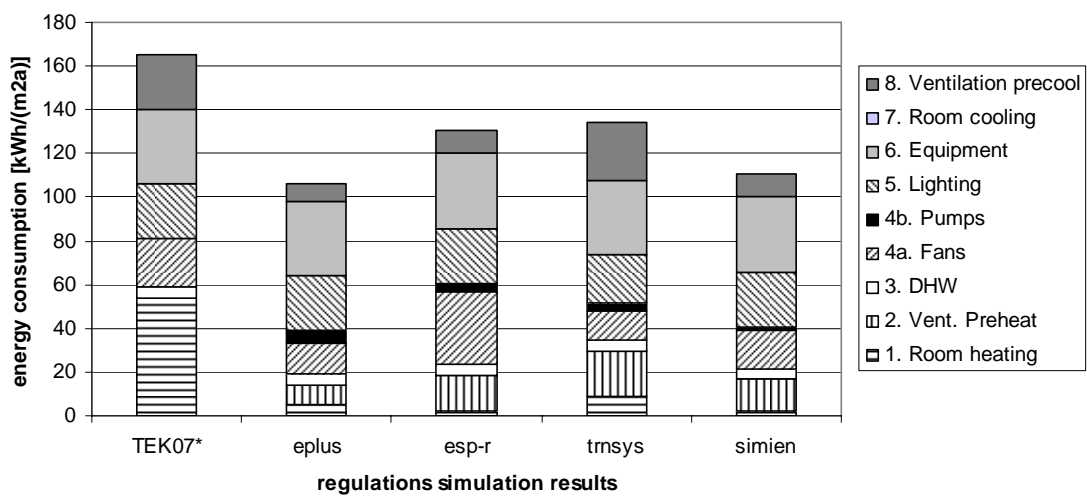

Figure 6 Fan power for typical summer period



Note *: 4b. fans included in 4a. pumps; 2. Vent. Preheat included in 1. Room heating

Figure 7 Summary of simulation results