

ENERGY PERFORMANCE OF BOREHOLE THERMAL ENERGY STORAGE SYSTEMS

Hiroshi Ohga and Kenji Mikoda

Architectural & Engineering Division, Obayashi Corporation
 2-15-2 Konan, Minato-ku, Tokyo 108-8502, Japan

ABSTRACT

This paper describes the energy performance of an underground thermal energy storage system that consists of high efficiency heat pump and Borehole-Heat-Exchangers (BHE). The energy conservation concept of this system is operation of the heat pump at higher efficiency using the Water-Source-Heat-Pump (WSHP). For this concept, the seasonal storage system using BHE under the ground is adopted as a Borehole-Thermal-Energy-Storage-System (BTES) with high efficiency WSHP. It is expected to operate heat pump on advantageous temperature conditions rather than using ambient air as heat source or heat sink. This paper provides the simulation model and the energy analysis of various parameters such as heating and cooling load characteristic, borehole design, and operation system. A series of simulation was carried out for an office building in Japan. As the results it was made clear that BTES could decrease the energy consumption of the HVAC primary system about 20% compared with that of conventional system using Air-Source-Heat-Pump (ASHP).

INTRODUCTION

Although BTES have become very popular in Europe and the United States, there are still few examples in Japan. The purpose of this paper is to study on an energy conservation performance of BTES in Japan using high efficiency WSHP and BHE. The performance of ASHP system is applied as a conventional system for comparison. When seasonal storage system is designed, the balance of annual cooling load and heating load plays the most important role. For example, if heat injection is larger than heat extraction (cooling load is larger than heating load), the ground temperature will rise every year and it will be impossible to use the underground heat storage system. Therefore, heat dissipation to the atmosphere by cooling tower is needed to balance heat injection and extraction quantity. On the other hand, when heating load is larger than cooling load, auxiliary equipment (boiler or ASHP) for heating is necessary. Since Japan has a various weather condition, this heat balance varies depending on

location. Therefore to design the size of auxiliary equipment needs a lot of careful study. It is necessary to decide number of borehole, depth, spacing and etc. according to peak cooling and heating load and annual load. In this study, a computer simulation model for designing and evaluating BTES was developed to specify the design parameters.

SYSTEM DESCRIPTION

Schematic of BTES is shown in Figure 1. This cooling and heating system is the closed-loop BHE coupled with the heat pump. This consists of a high

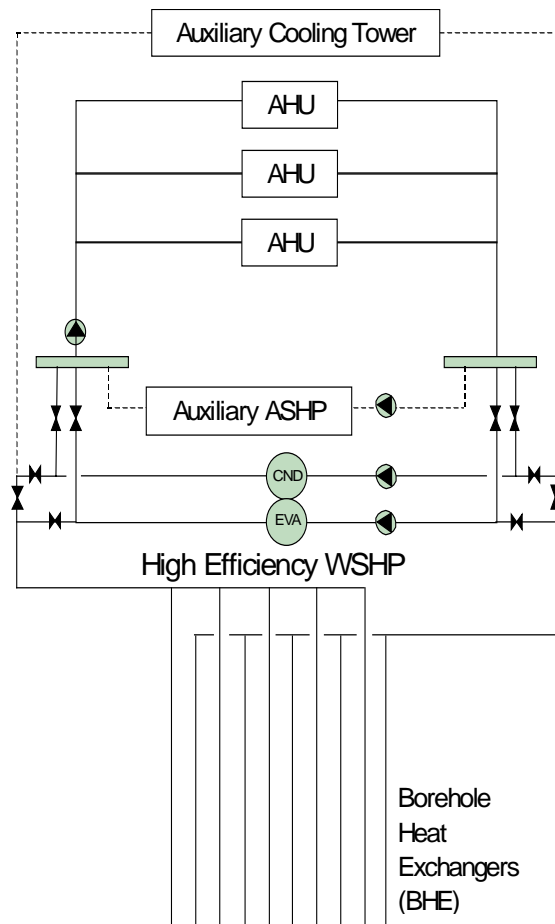

Figure 1 Schematic of BTES

efficiency screw WSHP with new counter flow gas-liquid heat exchanger and BHE, which has polyethylene double U-pipe in 50m-depth borehole as shown in Figure 2.

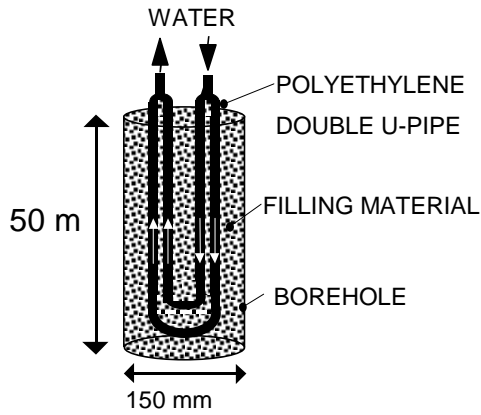

Figure 2 Borehole Heat Exchanger

In order to balance the heat injected to the ground and extracted from the ground, a cooling tower or ASHP is added. For example, if heat injection is greater than heat extraction, a cooling tower is used as shown in Figure 3.

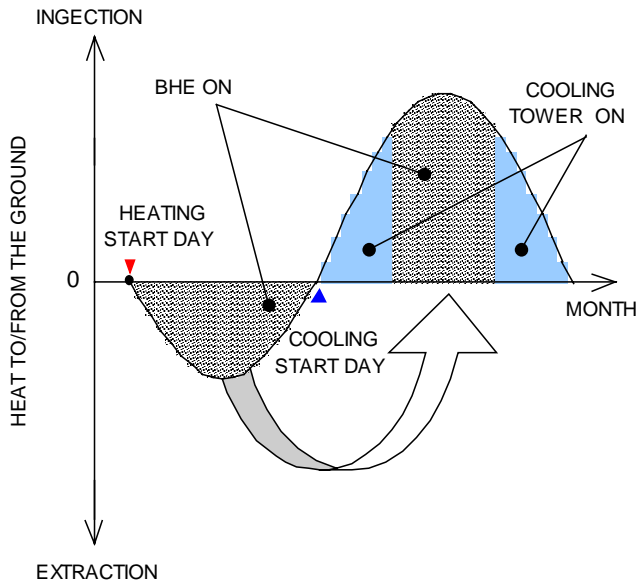

Figure 3 Annual Heat Balance

MODELS

The simulation models consist of the borehole model and HVAC primary system models shown in Figure 4. The parameters between these models are entering/leaving temperature of BHE and water flow rate. These models can calculate primary system energy consumption and ground temperature under the given conditions regarding geological and weather conditions.

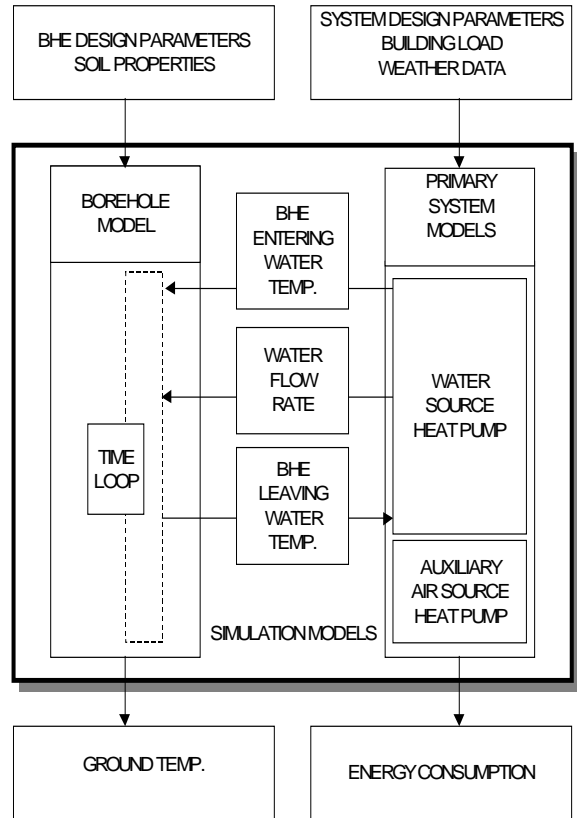

Figure 4 Information Flow Diagram

Borehole model

In order to analyze underground thermal energy, a horizontal 2-dimension model for BTES was used. It is based on the algorithms presented by Hamada et al. (1996) to describe thermal behavior of BHE. In order to ease the mathematical model about thermal response of vertical U-pipe, the equivalent diameter method shown in Figure 5 (Deerman and Kavanaugh, 1991) was applied.

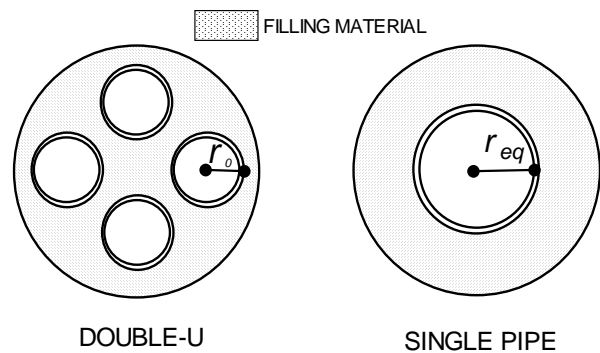

Figure 5 Equivalent Diameter Method for Double U-pipe Type

The equivalent diameter for a single pipe is calculated by the following equation:

$$r_{eq} = 2r_0 \quad (1)$$

where

r_{eq} = equivalent outside diameter (m)

r_0 = outside diameter of double U- pipe (m).

Thermal resistance of the pipe using equivalent diameter method is calculated as follows:

$$R = \frac{1}{nC_f} \left(\frac{1}{2\pi\alpha r_i} + \frac{1}{2\pi\lambda_p} \ln\left(\frac{r_o}{r_i}\right) \right) \quad (2)$$

where

R = thermal resistance (m·K/W),

C_f = correction factor,

r_i = inside diameter of double U-pipe (m),

α = convective heat transfer coefficient (W/m²·K),

λ_p = thermal conductivity of pipe (W/m·K),

n = number of pipes.

Primary system models

The primary system model calculates the required energy rates from the required cooling and heating load. The hourly energy consumption of primary equipment can be calculated by equipment power under design condition, power correction factor relating power at off-design conditions to power at design conditions, and part load power function relating part-load power to full-load power. Figure 6 through 9 show power and capacity correction factors based on manufacturer's published catalog data. The design point is located on the performance curve at the intersection of the power and the capacity curve. The COP at design conditions is shown at design point. The COP at off-design conditions is calculated based on power and capacity correction factors and the COP at design conditions. Leaving water temperature of WSHP is calculated based on power consumption. It is assumed that entering water temperature of BHE is equal to leaving water temperature of WSHP. If the auxiliary cooling tower

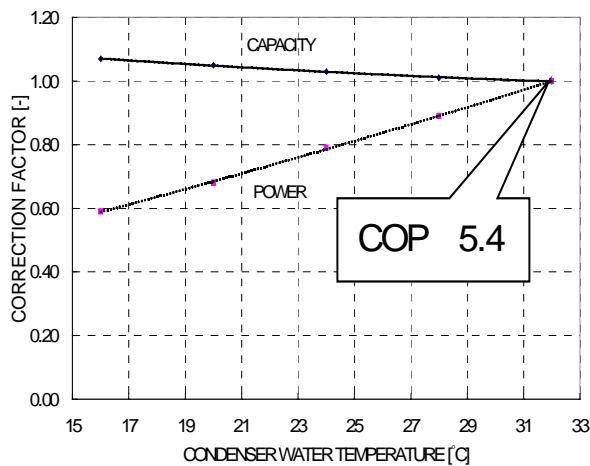

Figure 6 Performance Curves of High Efficiency WSHP (Cooling)

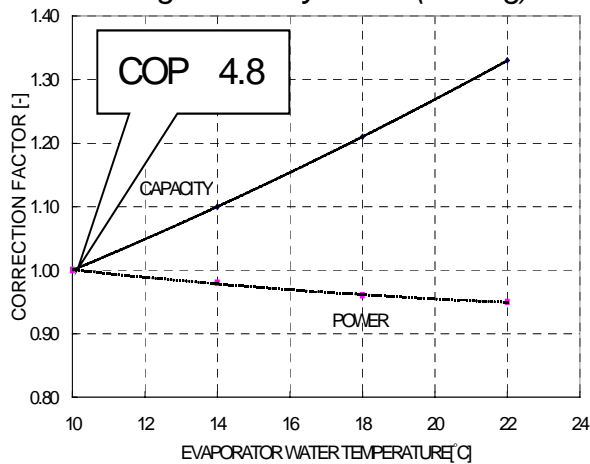

Figure 7 Performance Curves of High Efficiency WSHP (Heating)

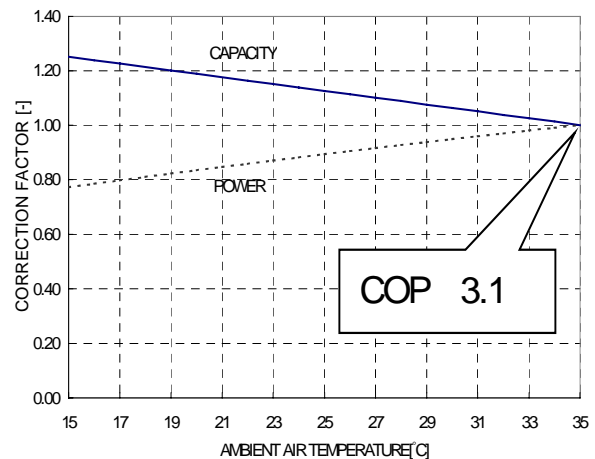

Figure 8 Performance Curves of ASHP (Cooling)

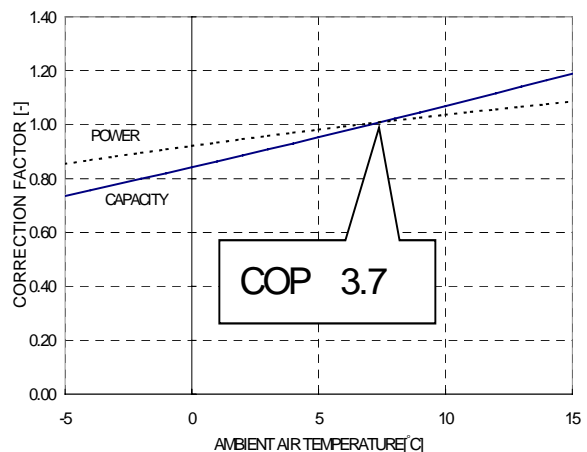

Figure 9 Performance Curves of ASHP (Heating)

is required, leaving cold water temperature of a cooling tower is calculated by using a function (Stoecker 1989) of entering the air wet-bulb temperature and the range.

Building Load model

Figure 10 shows the cooling and heating loads for this study used as input data for the primary system model. A 8,000m² office building were selected and its ratio of annual cooling and heating load was set to 1 to 1, and 3 to 1 by changing building data shown in Table 1. A rotary heat exchanger affected heating load and the ratio. Total energy recovery efficiencies is assumed 60%. These loads were calculated using weighting factor method.

CASES AND VARIABLES STUDIED

The nine cases shown in Table 2 were studied in this paper. In Case 1 through 7 annual cooling load and heating load were balanced. In Case 8,9 annual loads were unbalanced. In Cases 1 thorough 3 the effects of borehole increase were compared. In Case 4, the high efficiency WSHP with cooling tower for cooling only and auxiliary ASHP for heating only were examined. This system was not coupled with BHE. In Case 5, base load operation of the high efficiency WSHP and auxiliary ASHP for heating were examined. In Case 6, high efficiency filling material was examined. In Case 7 and 9, the conventional ASHP were examined to compare with 1 through 6 and Case 8. In Case 8, BTES on unbalanced annual load was examined. Because of the borehole with a depth more than 50m costs very high in Japan, the depth of borehole is fixed 50m, and the high performance double U-pipe is selected to reduce the number of boheholes for cost saving.

Table 1 Building data

Ratio of Annual Cooling to Heating	1:1	3:1	Units
Location	Sendai	Tokyo	-
Latitude	38.27	35.68	°N
Longitude	140.9	139.8	°E
Design Temp.			
Cooling	31.7	33.6	°C
Heatig	-3.2	-0.6	°C
Design Room Temp.			
Summer Peak	26	26	°C
Winter Peak	22	22	°C
Off Peak	25	24	°C
Cooling Season	May - Oct.	Apr. - Oct.	-
Rotary Heat Exchanger	OFF	ON	-
Building Type	Office, 8-stories		-
Total Floor Area	8000		m ²
Ext. Wall	Aluminum Siding, 150mm Concrete with 25mm insulation,		-
Windows	Reflective Single		-
Floor	120mm Concrete Slab		-
Partition	120mm Concrete		-
Lights	12		W/m ²
Equipment	23		W/m ²
People	0.12		Person/m ²
Outdoor Air per Person	8.3		L/s

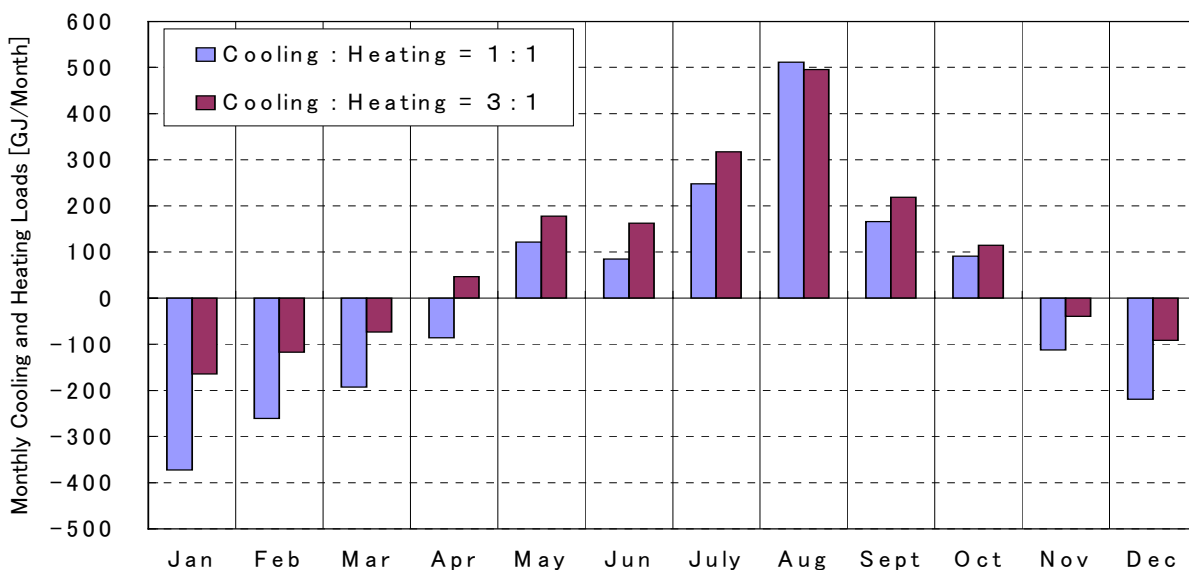
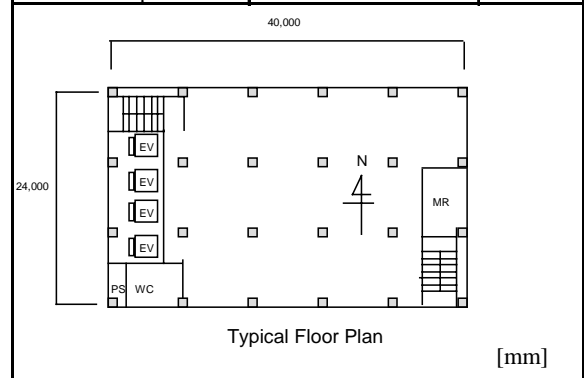

Figure 10 Building Loads

SIMULATION RESULTS

Annual power consumption of the primary systems and the energy consumption reduction rates of all cases are shown in Table 3 and Figure 11. These reduction rates are compared to a conventional ASHP system (Case 7, Case 9).

The water temperature of BHE

Figure 12 shows the detail results of Case 1. Figure 12a indicates the simulation results of summer peak days. The maximum entering/leaving water temperature of BHE for three days are 39.4°C/34.6°C. The temperature descent of nighttime is about 7 °C. The temperature at 8 a.m. (operation start time) changed from 16°C to 26°C in three days. Figure 12b indicates the simulation results of winter peak days. The minimum entering/leaving water temperature of BHE for three days are 0.6°C/4.0°C. The temperature rise of nighttime is about 4 °C. The temperature at 7 a.m. (operation start time) changed from 9.8°C to 7.1°C in three days. Figure 12c shows annual leaving water temperature change of BHE. The size of seasonal swing is about 20°C up and 10°C down from the annual average.

The Effect of BHE

The system of Case 7 is the conventional ASHP. The system of Case 4 is adapted high efficiency WSHP coupled with the cooling tower as the cooling equipment in Case 7. These systems are not coupled with BHE. The comparison between Case 4 and Case 7 shows the effect of high efficiency WSHP. The reduction rate of Case 4 is 10%. Furthermore the comparison between Case 1 and Case 7 shows the effect of high efficiency WSHP and temperature

improvement using BHE. The reduction rate of Case 1 is 18%.

The Effect of BHE number

Figure 13 and 14 present reduction rates, maximum and minimum entering temperature of BHE as a function of the number of BHE. Hi limit leaving condenser water temperature of WSHP is 45°C. In order to limit the entering temperature of BHE to 45°C, BHE are needed more than **N_{min}** (about 260 BHE) shown in Fig. 14. In consideration of initial cost, the number of BHE is decided to fit the operation temperature condition range. Pay back years are shown in Figure 15. When the number of BHE is increased from 300 to 400, the reduction rate is 4% up and the payback changes from 38 years to 47 years.

The Effect of the base load operation

The high efficiency WSHP performs base load operation in Case 5. 1/3 of required heat pump capacity is supplied by WSHP coupled with 100 BHE, and 2/3 is supplied by auxiliary ASHP. The energy consumption reduction rate is 7%. Although its energy performance is inferior to Case 1, the initial cost of BHE is 1/3.

The Effect of the high performance filling material

By use of high efficiency filling material, the energy reduction rate improved from 18% to 21%. The thermal conductivity of the material is assumed the twice of the conventional material. This effect is equivalent to about 100 BHE.

Table 2 Simulation Cases

Case	1	2	3	4	5	6	7	8	9	Units
Description	High Efficiency WSHP 300 Boreholes	High Efficiency WSHP 400 Boreholes	High Efficiency WSHP 500 Boreholes	High Efficiency WSHP + Aux. ASHP 0 Borehole	Base Load Operation of High Efficiency WSHP	High Efficiency Filling Material 300 Boreholes	Conventional ASHP	High Efficiency WSHP 300 Boreholes	Conventional ASHP	
Ratio of Annual Load Cooling: Heating	1:1	1:1	1:1	1:1	1:1	1:1	1:1	3:1	3:1	—
Number of Boreholes	300	400	500	0	100	300	—	300	—	—
BHE depth	50	50	50	—	50	50	—	50	—	m
Filling Material	Conventional	Conventional	Conventional	Conventional	Conventional	High Efficiency	—	Conventional	—	—
Main Heat Pump	High Efficiency WSHP	High Efficiency WSHP	High Efficiency WSHP	High Efficiency WSHP + Cooling Tower	High Efficiency WSHP	High Efficiency WSHP	ASHP	High Efficiency WSHP	ASHP	—
Auxiliary Equipment	None	None	None	ASHP	ASHP	None	None	Cooling Tower	None	—
Notes	Building		Boreholes		Simulation					
	Type of Building	Office Building	Type of U Pipe	Double-U-Pipe	Operation period		1year			
	Floor Area	8000m ²	BHE Spacing	3m	Ratio of Heat Pump Load for Base Load Operation		WSHP:ASHP=1:2			
	Number of Stories	8 stories	Initial Soil Temperature	13.8°C	Filling Material Property		Ratio of Heat Conductivity Conventional:High Efficiency =1:2			

The influence of ratio of annual cooling load to heating load

When the ratio of annual cooling load to heating load was changed to 3:1 of Case 8 from 1:1 of Case 1, the energy consumption reduction rate improved from 18% to 21%. Although WSHP is connected to the cooling tower in Case 8, it is not connected in Case 1. The ground temperature can be kept low until summer peak season by using a cooling tower during intermediate season. As a result, its COP is higher than that of the case using 300 BHE throughout the year.

CONCLUSIONS

Based on the simulation results, the following conclusions can be made.

1. The energy consumption reduction rate of the HVAC primary system of BTES is about 20% compared with that of a conventional system using ASHP. The simple payback is calculated 38 years. The installation costs saving is needed to compete

with ASHP.

2. Although the reduction rate of Base-Load-inferior to that of 300 BHE system, the initial cost of BHE can be reduced.
3. The number of BHE can be reduced by use of high efficiency filling material.
4. The ground temperature can be kept low until summer peak season by using a cooling tower during intermediate season. So its COP is higher than that of using BHE throughout the year. This system and the operation method are effective in unbalanced load.

ACKNOWLEDGEMENTS

The authors wish to acknowledge the support of Professor Kiyoshi Ochifuji and Dr. Yasuhiro Hamada. This study was a part of Advanced Research and Development of an Underground Thermal Energy Storage System provided by New Energy and Industrial Technology Development Organization.

Table 3 Annual Power Consumption and Reduction Rates

Case		1	2	3	4	5	6	7	8	9	Units
Annual Power Consumption	W Heat Pump	119	111	107	42	108	112	0	82	0	MWh/year
	S Pump and Fan	43	43	43	27	14	43	0	44	0	MWh/year
	A Heat Pump	0	0	0	96	52	0	174	0	140	MWh/year
	S Pump and Fan	0	0	0	12	8	0	23	0	19	MWh/year
	Total	162	154	150	178	182	155	197	126	159	MWh/year
Reduction rate of Energy Consumption		18	22	24	10	7	21	0	21	0	%

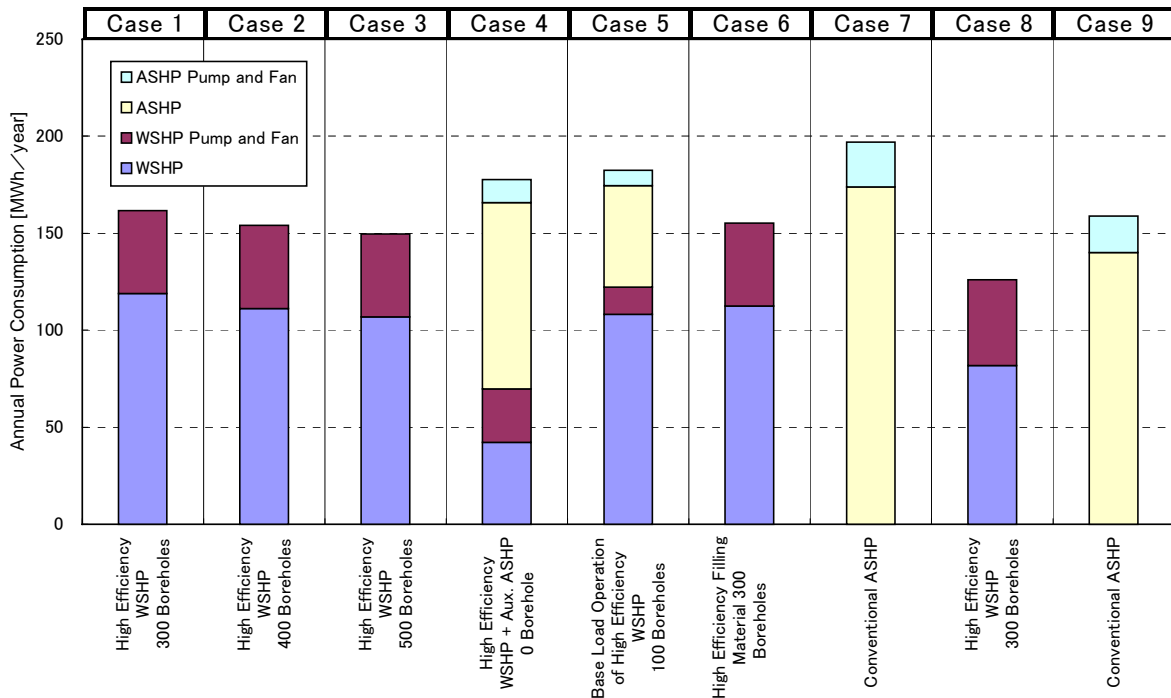
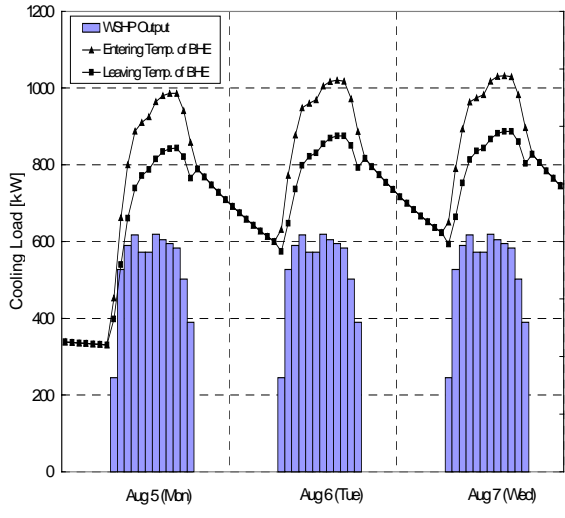
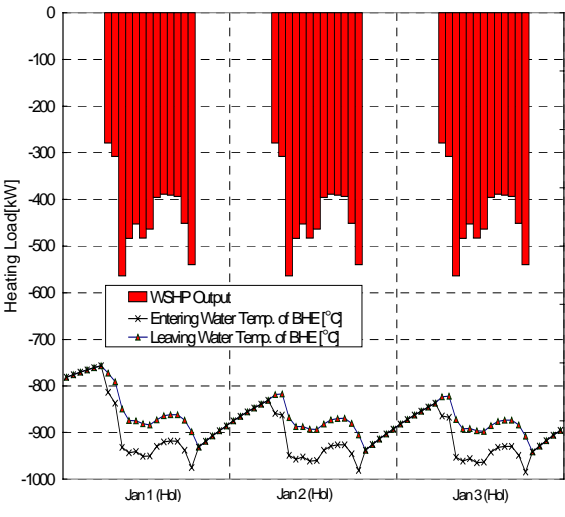

Figure 11 Annual Power Consumption



a) Simulation Results of Summer Peak Days



b) Simulation Results of Winter Peak Days

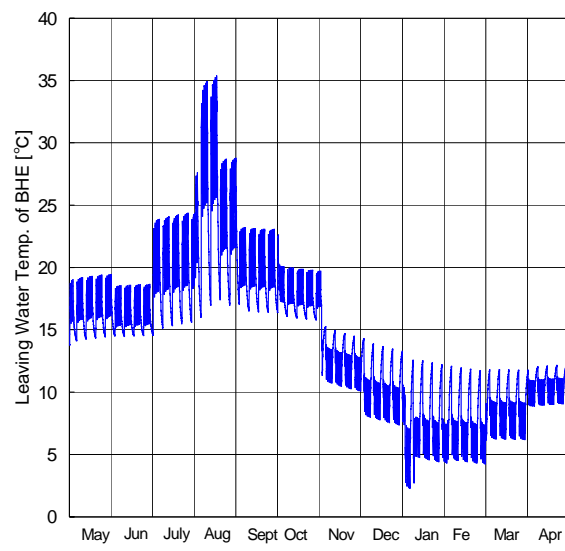

c) Annual Leaving Water Temp. Change of BHE
Figure 12 Simulation Results of Case 1

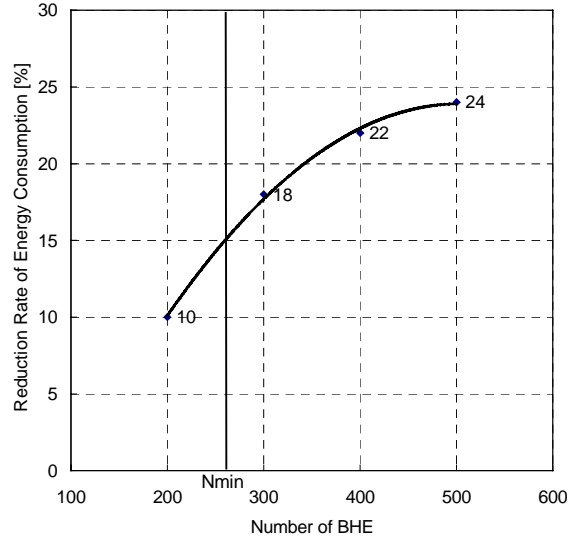

Figure 13 Reduction Rate vs. Number of BHE

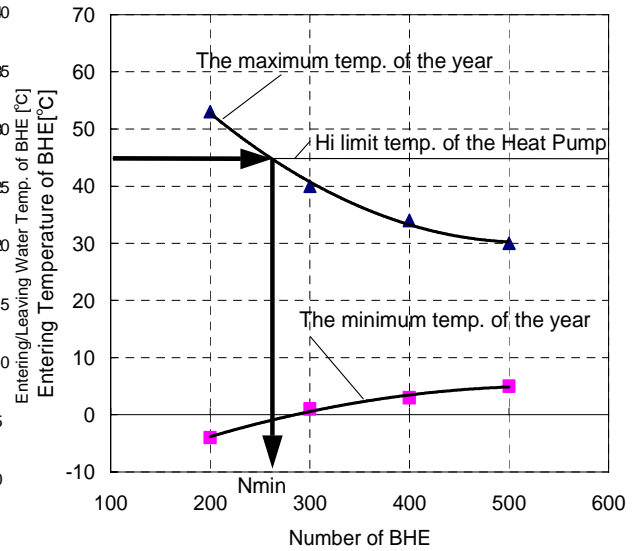

Figure 14 Entering Temp of BHE vs. Number of BHE

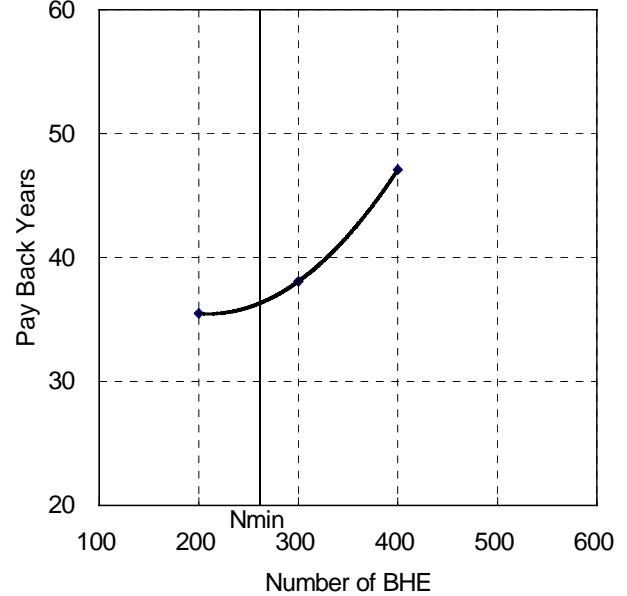

Figure 15 Pay Back Years vs. Number of BHE

REFERENCES

Hamada, Y., Ochifuji, K., et al. „A Study on the Heating and Cooling System by the Thermal Storage with Vertical Underground U-tube Heat Exchangers“, Trans. of SHASE, No.61, pp45-55, Apr. 1996.

Deerman, J. D. and Kavanaugh, S. P., „Simulation of Vertical U-tube Ground-coupled Heat Pump Systems using the Cylindrical Heat Source Solution“, ASHRAE Transactions 97(1), pp287-295, 1991.

Stoecker, W. F., „Design of Thermal Systems, 3rd Edition“, McGraw-Hill, pp64-65, 1989.