

BUILDING SIMULATION – SOME SWISS EXPERIENCES

Gerhard Zweifel, Matthias Achermann and Markus Duerig
University of Applied Sciences of Central Switzerland
Lucerne School of Engineering+Architecture
CH-6048 Horw - Switzerland

ABSTRACT

This paper gives an overview about the use of building simulation in Switzerland. It focuses 4 different areas:

- Simulation of double façade buildings using a unique technique for the combination of thermal and interzonal air flow simulation.
- Simulation as a tool for standard or building code compliance in combination with tailored user interfaces, where the special issue is a common data base, avoiding entering common data for the different applications separately.
- Building Simulation in engineering education
- Results of program validation activities and their use for evaluation of new programs

INTRODUCTION

The authors are – besides activities in research projects – frequently involved in consulting work in the building design process. Building simulation is offered as a service to architects and HVAC engineers.

One of the most important experiences in the use and application of building simulation programs is, that many questions to be answered by simulation tend to be ahead of the capabilities of the simulation software in terms of technology. The ‚normal case‘ building with an every day system is not of interest, because there is enough experience to deal with it without the use of simulation software. Examples of problems to be considered by simulation are cases with buoyancy driven natural ventilation, be it in the occupied zones themselves or – more often – in rooms adjacent to those such as atria or double facades. Other cases are buildings with building element integrated systems (thermo active building components).

However, also in ‚normal‘ cases some questions such as the energy demand of variable volume systems under variable building load conditions cannot be answered without simulation. If it is to be used in these cases, this must be as easy to apply as an

ordinary ‘hand’ calculation tool, and there must be a reason for it such as energy code or standard compliance.

This last requirement is covered by a program family (IDEA) developed at our institute, a part of which uses simulation with the DOE-2 program and is described below. It allows the HVAC engineers to perform the simulations themselves without knowledge of the simulation program itself.

One important background for this development is the introduction of building simulation in engineering education. As the only institution in Switzerland training HVAC engineers, we have the objective to introduce building simulation as an important tool for building and system optimisation to the students. The IDEA software family is always used as the starting point.

Although many problems can be solved by using the current technology, a new generation of simulation program is necessary in order to become more efficient and more flexible. Component based simulation is the right way to better keep track of the technology conformity of programs. Some of the well known programs in this direction have the disadvantage that new component models need to be programmed in a language like FORTRAN, and the way the program treats the problem may lead to instability of the model. However, a newer generation of program is available, and a specific product is under examination as a replacer for the DOE-2 program: the IDA program from the Swedish company EQUA Simulation Technologies in Stockholm. This program features:

- Different user levels, starting from the problem tailored ‚wizzard‘, going to the component based simulator with a graphical interface for linking the component models and ending up at the expert level, enabling the user to build up his own models
- A special, program language independent model description format, the ‚neutral model format NMF‘
- Full graphical interface

USER INTERFACES

A family of programs ('IDEA') was developed to perform the technical calculations according to Swiss standards. The special feature of this family is that all the programs use the same data base, which leads to the advantage that data needed for more than one of the different calculations have to be entered once and not repeatedly. The data base is arranged in a way that a project can easily be managed and transported. It consists of at least two (MS ACCESS) files: one general project file and one 'version' file. If more versions of the same projects are entered, the number of files grows with the versions. All the different programs have a certain view of this data base and one program will not use the whole data base. E.g. program 1 in figure 1 will treat and show the green part of the data base because this is relevant for the calculation. Another program (program 2) will show a different part of the data (red). The overlapping part (black), which is common to the two calculations, is to be entered only in one of the two programs and will then appear in the other programs, too.

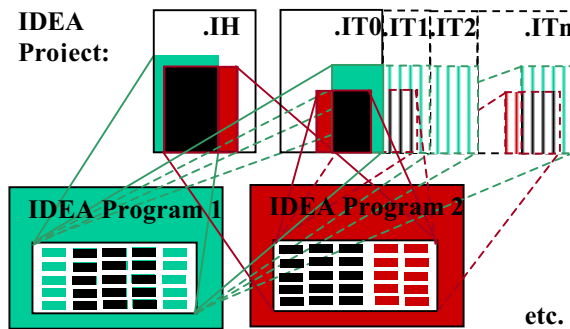

Figure 1: Data base and common data in IDEA program family

Some of these programs require a building simulation. For this purpose, a DOE-2 input file is automatically generated and DOE-2 is running completely hidden in the background. The user does not need to know about the simulation program. All the data to be entered are of evidence to him due to the task he has to perform. This is due to the fact that these calculations do not make use of all the possibilities of the simulation program in terms of input and output. This means the user interface is also a filter and guidance tool. For the program developers on the other hand, this leads to the necessity of definition of many default values, more than the program itself would offer.

One very simple program is the one for the cooling load calculation (figure 2). It only makes use of the

'LOADS' part of the DOE-2 program and not even performs a simulation with real weather data, but only two 'design day' runs.

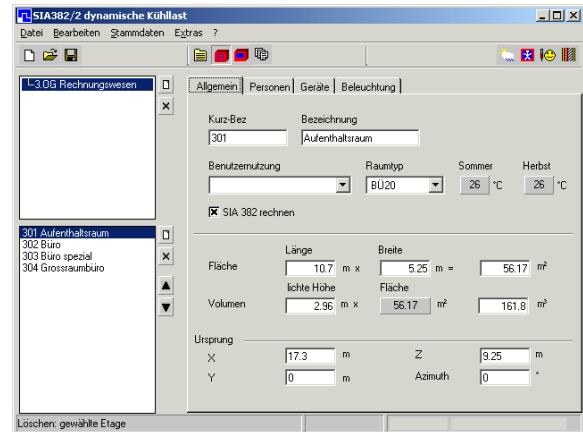

Figure 2: User interface of IDEA cooling load program

Another program is the one for the 'prove of need for cooling' (figure 3). This program performs an overheating risk assessment for the selected room and shows the number of hours with temperatures exceeding a certain comfort limit.

This tool is a very convenient tool to quickly show the effect of different building properties like shading devices, building mass or ventilation strategies.

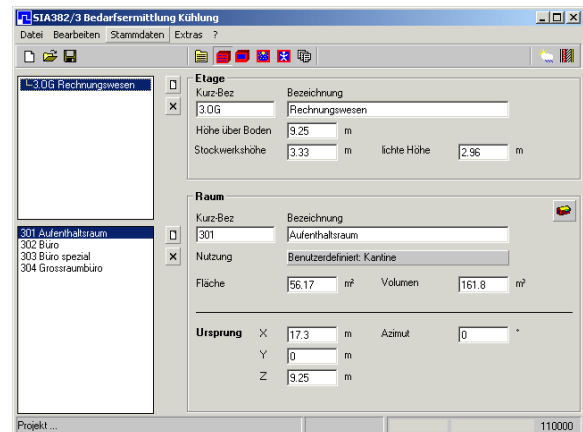

Figure 3: User interface of IDEA overheating risk assessment program

The two figures of the user interfaces are mainly shown because they nicely demonstrate that they treat one and the same project but show it in different views.

This program family has led to a spread out of building simulation among the Swiss HVAC engineering offices to a much larger extent than it would have been without.

New developments are done in the area of inter-connection to other programs. A link to a simulation

based optimization program for heat recovery systems of one of the leading manufacturers has been established recently which adds the feature of energy demand calculation of ventilation and air conditioning systems to the package.

SIMULATION IN HVAC ENGINEERING EDUCATION

To some extent, building simulation with the DOE-2 Program is part of the education plan in the HVAC engineering department at HTA Luzern. The objective is not, that all students become experts in building simulation and will be able to perform a complete DOE-2 simulation study in their own, although this may be the case for some of the more interested students. The objective is that the graduated engineer

- Have an idea what the possibilities of the program(s) are able to decide and benefit a simulation study could bring to a specific project
- are able to judge results of simulation studies done by third party experts
- have an idea what problems third party experts can face

It is emphasized during this education process that building simulation is a very powerful tool for what is called 'integral design'. This means it is able to cover the different disciplines of the building design and to show their interconnections.

The process consists of two steps:

- A workshop of 4 days for all students, where they are lead step by step through the use of the program
- The choice of a topic for their semester project and/or diploma thesis which allows/needs the application of simulation

The procedure of the workshop is as follows:

- Introduction of simulation techniques and the DOE-2 program
- Start with a project which the students do not know in detail, where they get the data base for in the IDEA cooling load program which they are familiar with.
- Automatic generation of a DOE-2 LOADS input file
- Addition of a predefined DOE-2 SYSTEMS input
- Analysis of this input file by the students. For this they are lead by a set of questions about the

project they have to find the answers for. During this step, they learn at the same time the input structure of the program and the qualities and settings of the project. Besides the program manuals they have a power point based introduction tool with hyperlinks as a help to find their way through the input. The teaching persons can be consulted.

- Brainstorming session about possible areas of investigation (such as lighting, window properties, temperature setpoints, ventilation strategies)
- Performing of parametric studies in different, limited areas in groups
- Presentation of the group results to the rest of the class
- Second round of parametric study in groups, but this time without limits in areas of interest. The goal in this step is to bring the overall energy consumption of the given project as low as possible.
- Presentation of final results to the class. An award is given to the best group.

The students can choose a simulation relevant topic for their semester project, which in most cases is continued in their diploma thesis (bachelor degree). Since this is not mandatory, the students who chose such a topic are normally highly motivated, and in some cases really high quality work comes out.

As an example, in one recently completed project a large building products and do-it-yourself market store was investigated by a group of two students.

The lightweight building has no mechanical system apart from some fan coil units for heating. Ventilation and cooling is provided by openable rooftop louvers, which are also used as smoke release openings, and supply openings in the façade (mainly the entrance doors). It features also an attached sunspace-like garden center, which can be used as supply air path (figure 4).

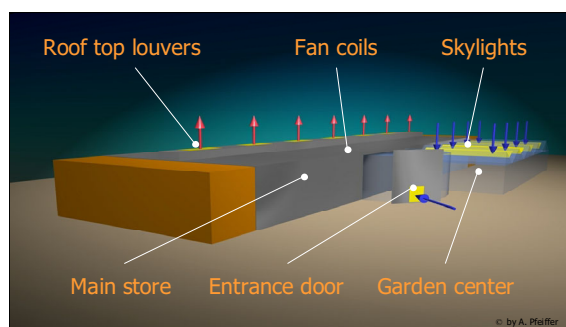

Figure 4: Diy market concept

A variety of different ventilation and control strategies was examined in order to provide enough summer cooling effect without the risk of draught problems.

The study involved the use of thermal simulation (DOE-2) as well as interzonal air flow simulation (COMIS). Some local aspects were even investigated with computational fluid dynamics (CFD, Flovent). A first version of the program coupling technique shown in the double façade chapter below was developed in the frame of this project.

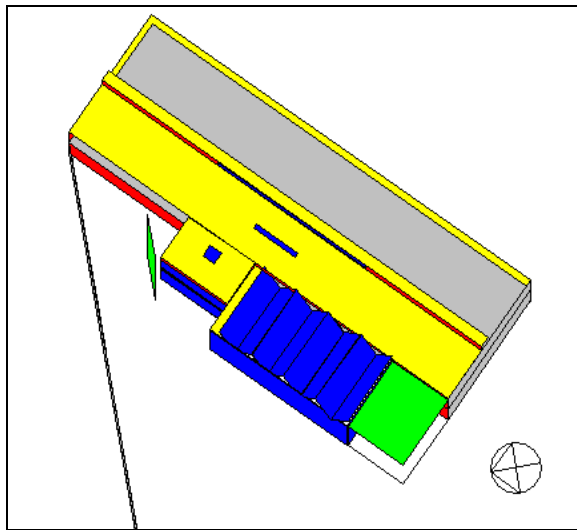

Figure 5: Graphical representation of building simulation input

For the thermal simulation, the actual space of the hall was divided into two zones to represent temperature stratification. This was crosschecked with CFD calculations. Therefore the building input contents 3 zones: Store occupied zone, store air space above occupied zone and sunspace (garden center).

The air flow simulation had to consider different situations with different air flow paths and directions (figures 6 and 7).

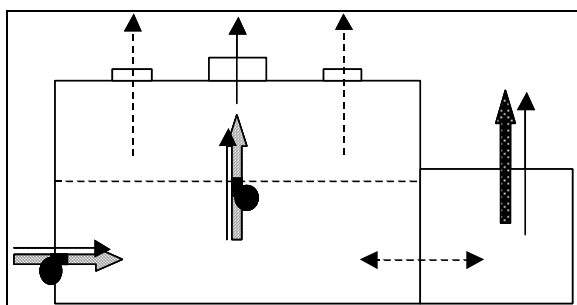

Figure 6: Air flow concept for daytime cooling

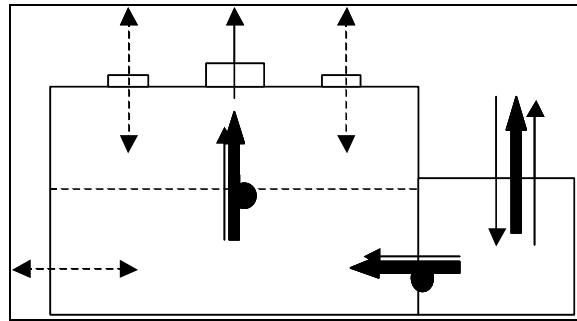

Figure 7: Air flow concept for night cooling

Due to the large variety of possible air flow paths the combination of air flow and thermal simulations was rather complicated and involved both the infiltration and mechanical ventilation possibilities. Separate systems had to be defined for the 3 zones in order to properly assign air flow rates and supply temperatures, and 'functional inputs' were involved.

It was possible to validate the results against measured temperature values, although these were not of very high accuracy. But this lead to a correction of the input parameters.

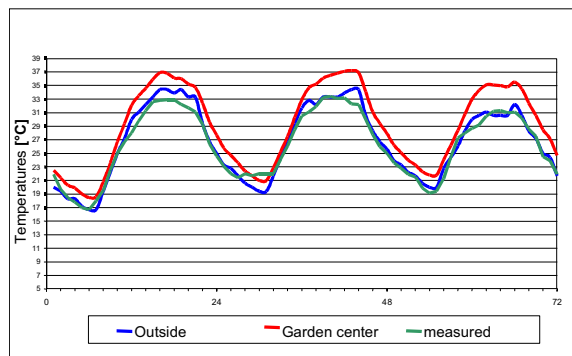

Figure 8: Temperature in garden center, measured and simulated, before optimization of input

The conclusions drawn from the calculations can be summarized as follows:

- Acceptable room conditions could be reached with night ventilation strategies only; daytime ventilation with a high draught risk for customers and especially checkout counter personnel can be eliminated
- Additional openings in the façade do not significantly affect the thermal situation
- A foreseen operation of fans to support cooling is unnecessary, resulting in energy conservation

SIMULATION OF DOUBLE FACADES

One of the situations, where simulations are frequently asked for in the building design process is the use of double façades. A normally fully glazed second skin is put in front of the actual façade. They are favoured by architects for different reasons:

- Noise protection
- Protection of shading devices on high rise buildings
- Architectural

This construction also has some disadvantageous properties, among which the most important is the danger of overheating in the space between the two skins. Natural ventilation is the most popular way to prevent this, but there is great uncertainty in respect of the effectiveness of it and of the design of the relevant elements. A typical situation of such a building part is shown in figure 9.

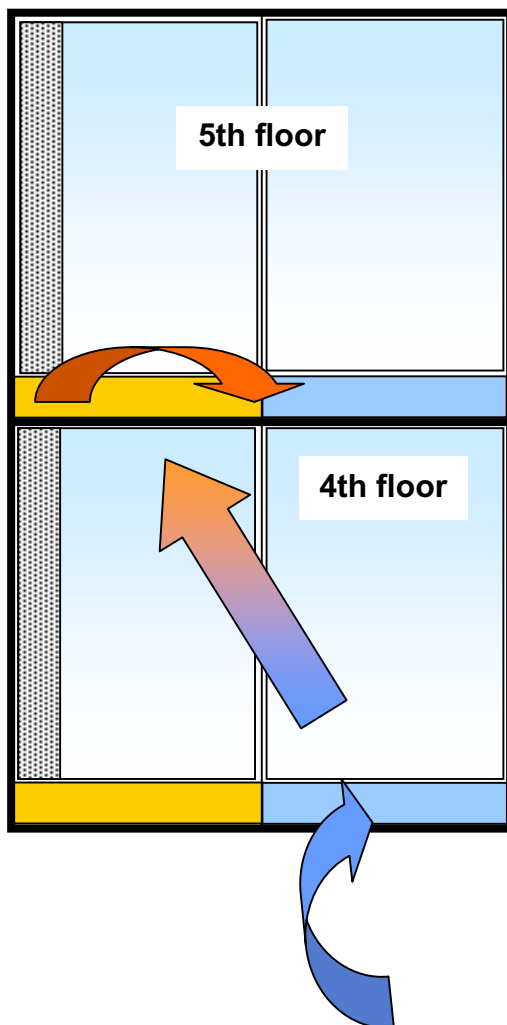

Figure 9: Elevation view of double façade with layout of glass areas and ventilation openings

For several reasons such as acoustic transmission and temperature stratification, the double façade is normally separated into floor-by-floor sections. Ventilation openings are put at the bottom and at the top of each section. In order to prevent the air escaping from one section from entering the section above, the openings are shifted sideways by one glass field, which leads to a diagonal flow direction in the façade section (figure).

The ventilation openings have some weather protection grills. In the case presented here, there are additional openable glass shutters to provide a larger opening for higher ventilation rates during hot summer periods. Also, it is possible to open some of the inner windows towards the façade plenum to provide ventilation to the inner room. These additional features are not always present.

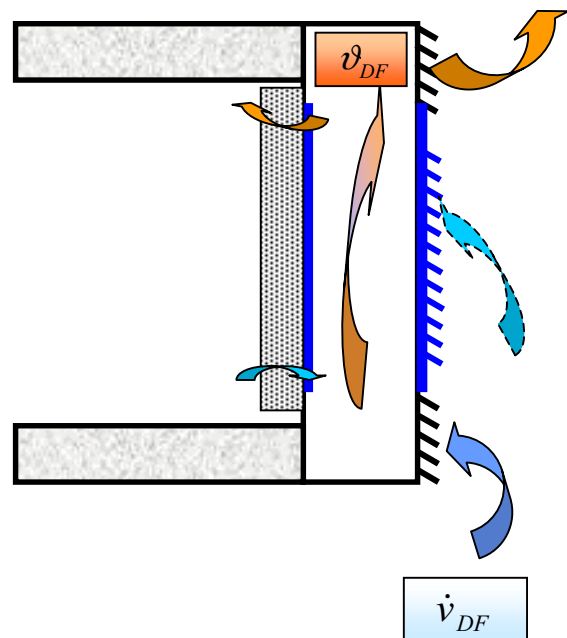

Figure 10: Cross section of double façade with layout of ventilation openings

For the calculation of these cases there are tools needed which are able to predict temperatures in fully glazed rooms and also to calculate air flow rates due to natural convection.

Many of the current thermal building simulation programs do not provide the possibility of air flow calculations. They usually need the air flow rate as an input. On the other side, there are interzonal air flow calculation programs which do not contain a dynamic model for the prediction of temperatures. They need the temperatures as an input to correctly consider buoyancy effects. This classical situation is schematically shown in figure 6.

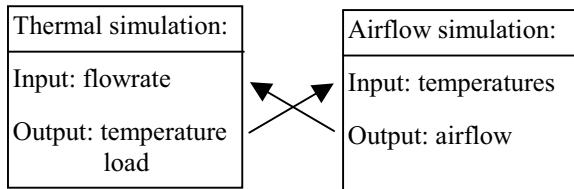

Figure 11: Crossover dependency of simulation categories

The combination of these two calculation types is therefore necessary to properly calculate the thermal behaviour of double façades.

Developments have been made to combine programs of these two types, e.g. by making the COMIS air flow program a 'type' in the TRNSYS thermal program, which leads to an hour-by-hour iteration between these two calculations [1].

However, a quite simple and easy to handle way of such a program combination was developed and applied to consulting jobs several times, using the programs DOE-2 and COMIS. The method is based on the restriction that only the buoyancy effect determines the air flow rate. Therefore the only parameter influencing the flow rate is the difference between the double façade plenum temperature and the outdoor temperature. Under this circumstance it is possible to simplify the procedure: First a model for the double façade air flow rate calculation is created (figure 12).

This is used to do an independent calculation of the air flow rates as a function of the difference between façade plenum and the outdoor temperatures. Not a weather file, but simply a range of temperatures is used to calculate to determine a function upon the results by curve fitting (figure 13).

This function is then put in an EXCEL worksheet, where a macro is programmed to manage the whole iteration process (figure 14). This process including generation of DOE-2 input parts and triggering of the DOE-2 run is fully automatized and involves the steps

- DOE-2 run -> façade plenum temperatures
- Read DOE-2 result into EXCEL
- Calculation of air mass flow rates with function in EXCEL
- Integration of calculated flowrates in DOE-2 infiltration schedule (in EXCEL)

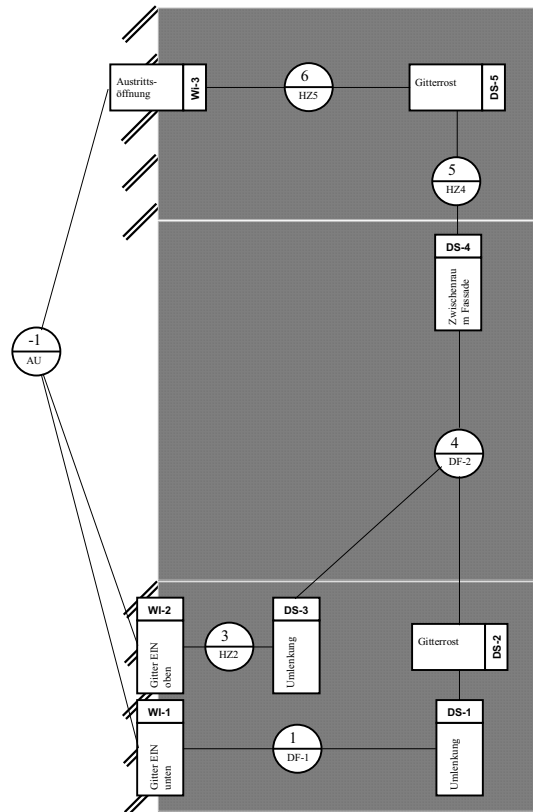

Figure 12: Network model of the air flow calculation

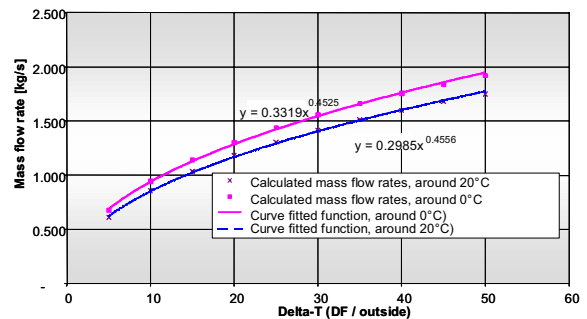

Figure 13: Functions for mass flow rate through façade plenum

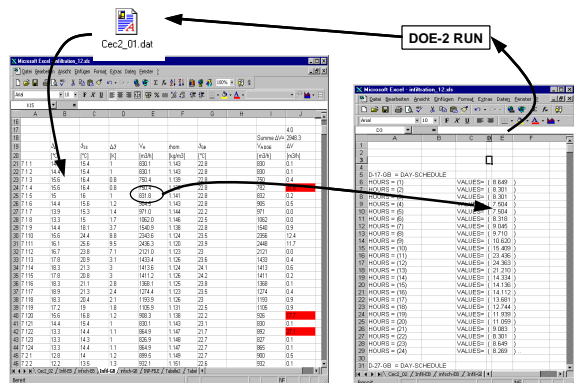

Figure 14: Iteration management in EXCEL

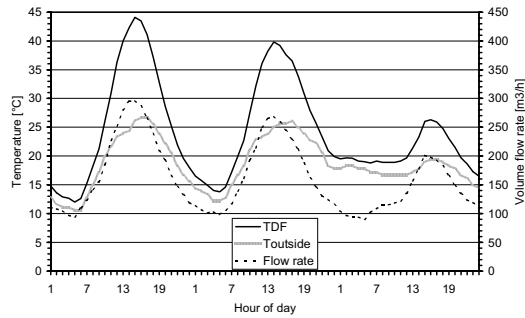

Figure 15: Double façade temperature and air flow rate for 3 summer days

As a typical result, figure 15 shows the temperatures and flowrates in the façade plenum. Different glass types, shading devices and the design of the necessary ventilation openings are the most frequent questions.

In one case, a CFD simulation was used instead of the interzonal air flow calculation. In this case, an atrium in the center of the building was to be used for the natural ventilation of the adjacent spaces. Other rooms should be ventilated with the open windows at the outward façade as supply air source.

The same technique was used to combine the results of the two calculations. Figure 16 shows a result for one of the considered offices ventilated against the atrium.

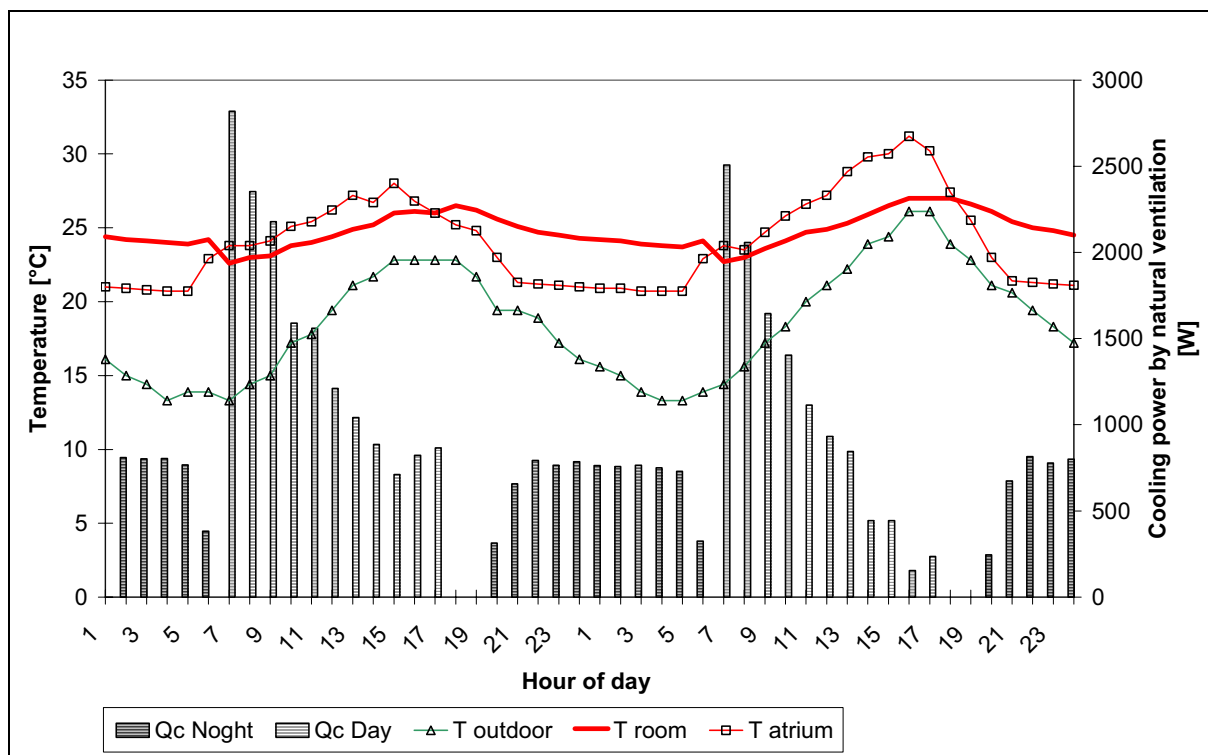

Figure 16: Results for temperatures and cooling power due to natural ventilation for an office ventilated against an atrium

VALIDATION AND TESTING

Although it was shown that with the current, rather old fashioned simulation tools it is possible to investigate naturally ventilated cases efficiently, there is a need for more flexible simulation programs.

The only reasonable answer to the problem mentioned above, that the programs' capabilities usually stay behind the building and HVAC technology is component based simulation programs, which allow for an easy and quick way to create own component

models and link those to a library of powerful existing models. This results in a tailored simulation and should be able to catch up with technology.

One candidate of a program which to the authors fulfills these requirements is the IDA program from EQUA Simulation Technologies in Stockholm, Sweden [2]. This program offers three levels of use:

- A simple 'wizard' level with restricted user freedom and a great part of predefined modeling issues

- A 'standard' level with more freedom, but using existing models from the library
- The 'advanced' level, where models can be changed and own models written, using the modeling language 'neutral model format, NMF'

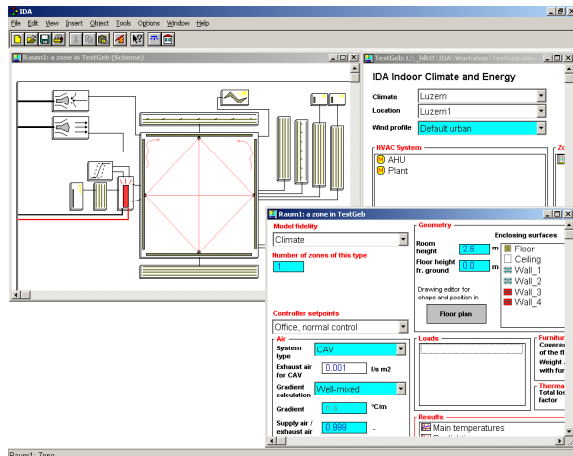

Figure 17: IDA Input structure

This program seems to fit many of the requirements for a new generation of simulation tool in the HVAC domain in Switzerland.

In the frame of the IEA SH&C Task 22 'Building Energy Analysis Tools' project, the IDA program is tested by performing some of the different validation tests. At the same time, the tests also show the handling of the program and its suitability for use in practice.

One important test, perfectly fitting as an 'entrance test', is the BESTEST suite from IEA SH&C Task 12 [3]. Due to its diagnostic power, it eases the detection of program faults, which was also the case with IDA and led to an improvement of the program. Figures 18 and 19 show some of the results of this exercise.

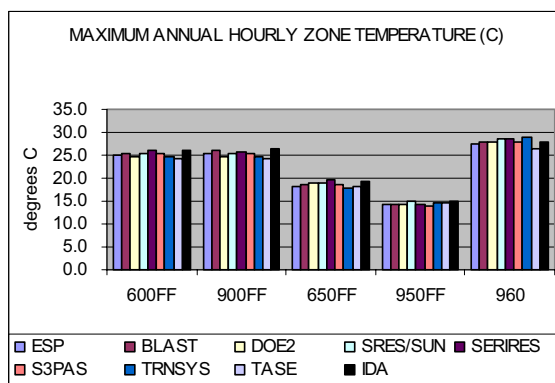

Figure 18: IDA results for free floating room temperatures in comparison with other programs

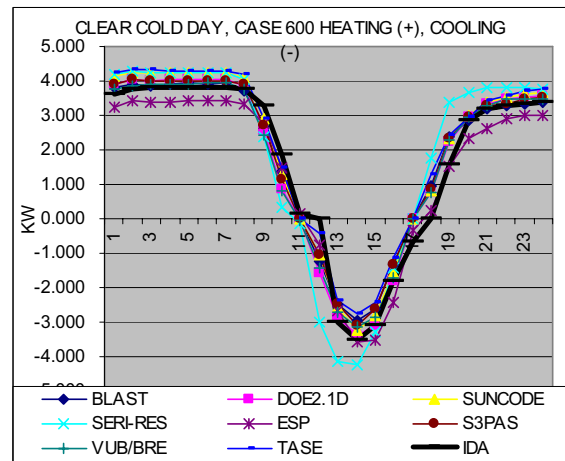

Figure 19: IDA results for heating/cooling loads in comparison with other programs

Empirical tests were made to show the program's capabilities in the HVAC domain. The empirical data origine from the Energy Research Station in Iowa [4].

For testing of the program's modeling possibilities, a new model for a ground-to-air heat exchanger was written in NMF an successfully tested.

CONCLUSIONS

Combined building thermal and air flow simulation is successfully used for consulting work. It is introduced in HVAC engineering education, Promising new tools are evaluated.

ACKNOWLEDGEMENTS

Thanks are given to the Swiss Federal office of Energy which supports the validation work. Thanks are also given to the colleagues of EMPA for the good collaboration in the air flow simulation area.

REFERENCES

- [1] Dorer, V., Weber A: Multizone Air Flow Mode COMVEN as Type 57 for TRNSYS, EMPA Technical Note, 1996
- [2] Vuolle, M. and Sahlin, P.: IDA Indoor Climate and Energy Application, EQUA Simulation Technology (www.equa.se)
- [3] BESTEST, Building Energy Simulations Test; http://www.eren.doe.gov/buildings/tools_directory/software/bestest.htm
- [4] Travesí, J: IEA SH&C Task 22 Building Energy Analysis Tools; Empirical Validation of Iowa Energy Resource Station Models; final report, 2001