

BUILDING THERMAL PERFORMANCE ANALYSIS BY USING MATLAB/SIMULINK

Nathan Mendes, Gustavo H.C. Oliveira and Humberto X. de Araújo

Pontifical Catholic University of Paraná – PUCPR/CCET

Thermal Systems Laboratory (LST) and Automation and Systems Laboratory (LAS)

Rua Imaculada Conceição, 1155

Curitiba – PR, 80.215-901 – Brazil

nmendes@ccet.pucpr.br; oliv@ccet.pucpr.br; araujo@ccet.pucpr.br

ABSTRACT

This paper is focused on a mathematical model applied to both building thermal analysis and control systems design. A lumped approach is used to model the room air temperature and a multi-layer model for the building envelope. The capacitance model allows to study the transient analysis of room air temperature when it is submitted to sinusoidal variation of external air temperature, representing a case study for a cold day in the south Brazil. To evaluate the building performance with thermal parameters, we use MATLAB/SIMULINK. In the results section, we show the influences of thermal parameters on the building air temperature, heating system performance, energy consumption and the advantages of using MATLAB/SIMULINK in building thermal and energy analysis.

INTRODUCTION

The mathematical description of building systems is complex due to several non-linearities and uncertainties such as convection coefficients, material properties, external weather, radiation effects, HVAC systems modeling and building schedules in terms of people, light and equipment.

In the literature, some researchers used MATLAB/Simulink to simulate thermodynamic models and analyze their characteristics in terms of efficiency and temperature control.

Hudson and Underwood (1999) presented a mathematical model for building simulation that can be represented by an RC electric circuit. The model is considered adequate for high mass buildings since they are predominantly capacitive.

Athienitis et al. (1990) and Dion et al. (1991) presented some approaches for the study of building thermal simulation and HVAC systems so that they could analyze advanced control strategies.

Mendes et Al. (2000a) elaborated a simplified model for control strategy analysis of heating systems for low mass constructions, which makes a worse

condition to be met by the heating system than that found in a real situation. Mendes et al. (2000b) improved their model by considering a capacitive multi-layer building envelope so that high mass constructions could be analyzed as well. The solar radiation was indirectly included by using the concept of equivalent temperature (air-sun). It was considered a dynamic lumped model so that it could be included the transmission loads and internal gains (lighting, equipment and people). The convection coefficients were considered constant and they adopted external temperature values varying as a sine function to simulate a cold day in south Brazil with a thermal amplitude of 14°C.

In this paper, the capacitive multi-layer model presented by Mendes et al. (2000b) is improved by adding the inter-surface long-wave radiation in the thermal model which means that we have included the radiation phenomena on all internal surfaces and on the heater surface as well. The model is implemented in the MATLAB/Simulink environment and comparisons are made in terms of building envelope capacitances, heater performance, heater convection and radiation losses and energy consumption sensitive analysis.

It is shown an efficient way to analyze building thermal performance and heating system control strategies by using MATLAB/Simulink in order to reach thermal comfort conditions and reduce energy consumption.

MATHEMATICAL MODEL

This work presents a dynamic model for thermal building performance analysis, which includes an electric heater. The room is considered hermetically closed with a uniform distribution of internal energy. We considered thermal losses just by heat transfer through the building envelope.

Applying the energy conservation equation for each element, the following mathematical formulation is obtained.

For the room enclosed by m surfaces, we find,

$$\rho_A c_A V_A \frac{dT_A(t)}{dt} = \sum_{i=1}^m h_{int} A_i [T_{n,i}(t) - T_A(t)] + h_c A_c [T_c(t) - T_A(t)] + D(t), \quad (1)$$

where ρ_A , c_A , V_A , $T_{n,i}(t)$, h_{int} , and A_i are respectively the air density, specific heat, room volume, the n -th layer temperature of wall i , the convection heat transfer coefficient and the i surface area. $T_A(t)$ the room air temperature and $T_c(t)$ the heater temperature.

The perturbation $D(t)$ includes the heat exchanged with the external air through low mass surfaces of the building envelope such as doors and windows and internal gains of energy due to equipment, lights and people. This term can be written as:

$$D(t) = \sum_{j=1}^m \frac{T_{eq}(t) - T_A(t)}{R_j} + q_p + q_e + q_l \quad (2)$$

where q_p , q_e and q_l are the internal gains under the presence of people, equipment and lighting system. The thermal resistance R of j -th surface is calculated as:

$$R_j = \frac{1}{h_{ext} A_j} + \frac{L_j}{\lambda_j A_j} + \frac{1}{h_{int} A_j} \quad (3)$$

where A_j is the low-mass surface- j area and h_{int} , the internal heat transfer convection coefficient.

For each layer k within the wall i , we can obtain the following energy balance equation:

$$\rho_{k,i} c_{k,i} V_{k,i} \frac{dT_{k,i}(t)}{dt} = K_{k+1,i} A_i [T_{k+1,i}(t) - T_{k,i}(t)] - K_{k,i} A_i [T_{k,i}(t) - T_{k-1,i}(t)] \quad (4)$$

where the thermal conductance K , can be estimated by a harmonic mean as:

$$K_{k,i} = \frac{1}{(L_{k-1,i} / 2) / \lambda_{k-1,i} + (L_{k,i} / 2) / \lambda_{k,i}}$$

where $L_{k,i}$ denotes the thickness of layer k and $\lambda_{k,i}$, its thermal conductivity.

The boundary condition for the external layer can be written as,

$$K_{1,i} (T_{2,i} - T_{1,i}) = h_{ext} (T_{1,i} - T_{eq})$$

T_{eq} represents the equivalent temperature (Air-Sun) given by the following expression:

$$T_{eq} = T_{ext} + \frac{\alpha I}{h_{ext}}$$

where α , is the wall external surface absorptivity, I , the total solar radiation (direct plus diffuse) and h_{ext} , the external coefficient of convective heat transfer.

For the internal layer ($k=n$) of the i -th wall, we can write the following boundary condition equation:

$$K_{n,i} A_i (T_{n-1,i} - T_{n,i}) = h_{int} A_i (T_{n,i}(t) - T_A(t)) + \sigma \varepsilon_c A_c F_{s,c-i} [T_{n,i}^4(t) - T_c^4(t)] + \sigma \varepsilon_i A_i \sum_{j=1}^m F_{s,j-i} [T_{n,i}^4(t) - T_{n,j}^4(t)]$$

where σ , ε and F_s are Stefan-Boltzmann constant, emissivity and shape factor.

However, for the floor ($i=5$), we consider for $k=1$, a constant soil temperature at a depth of 5m and we apply the boundary condition of imposed temperature.

The electric heater is globally modeled as:

$$\rho_c c_c V_c \frac{dT_c(t)}{dt} = Q(t) - h_c A_c [T_c(t) - T_A(t)] - \sigma \varepsilon A_c \sum_{i=1}^m F_{s,c-i} [T_c^4(t) - T_{n,i}^4(t)] \quad (5)$$

where $Q(t)$ is the energy rate generated within the heater by Joule effect, ρ_c , the heater density, c_c , the specific heat, V_c , the oil volume within the heater, h_c , heat transfer convection coefficient between room air and heater and A_c the heat exchange area.

The heating system sensor temperature $T_s(t)$ can be modelled as:

$$\rho_s c_s V_s \frac{dT_s(t)}{dt} = h_s A_s [T_A(t) - T_s(t)] \quad (6)$$

where ρ_s , c_s , V_s , h_s and A_s are respectively the sensor density, specific heat, volume, convection heat transfer between the sensor copper sphere and the air and the sensor heat exchange area.

SIMULATION PROCEDURE

The analysis of building thermal performance is done by the dynamic model implementation in MATLAB/Simulink environment. MATLAB is a software that contains a wide mathematical library that makes it much simpler for rapid prototyping than other programming languages such as C or Fortran. Simulink is MATLAB graphic user interface, which was especially built for dynamic systems simulation.

The model implementation in Simulink environment is made as it is illustrated in the diagram of Figure 1, where the building model is inserted in the block “Building Model” in the format of state equations. Therefore, to determine the state equations, we have considered a building envelope composed by three layers so that the state vector $x(t)$ contains besides the temperature of each building envelope layer, the temperatures of room air, sensor and heater as well. Thus, the model contains 21 state variables (6 envelope surfaces times 3 layers plus 3 state variables). Hence, the model described by equations 1-6, can be succinctly written in terms of state equation as:

$$\begin{cases} \dot{x}(t) = Ax(t) + Bu(t) \\ y(t) = Cx(t) \end{cases},$$

where $u(t)$ is the vector related to the model inputs such as the heater power, equivalent temperature, internal gains (people, lighting and equipment) and soil temperature. The output $y(t)$ vector corresponds to the room air temperature. The non-linear effects associated to the radiation heat transfer were implemented by the Simulink toolbox facility. The model parameters described in the model equations are gathered from ASHRAE (1993) and Incropera and De Witt (1998). For the electric heater, we have considered it as an equipment which has an oil volume of 2 liters.

It is analyzed the room air temperature for different model parameters when the outdoor temperature varies as a sinus function as it is shown in Fig.2. On the other hand, the soil temperature is kept constant as 15 °C and the initial temperatures for the room air and the building structure are assumed to be equal to 13 °C. This hypothesis is physically consistent since the initial conditions effects are not important in long-term simulations. The initial conditions are very important when it is required a dynamic building response for very short-term simulations. Table 1 presents the elements dimensions and thermal properties used in the simulations.

RESULTS AND DISCUSSIONS

In this section, a room air temperature sensitivity analysis is done in terms of thermal capacitance and thermal contribution of radiation heat transfer from heating system. We also analyze the heater performance and its instantaneous contribution relative to the room air heating process.

The building envelope thermal capacitance ($C=\rho cV$) effects on the room air temperature (T_a) are shown in Fig. 2. We notice that for the low capacitance case (10% of the reference value), the transient duration is

almost imperceptible. On the other hand, for the high capacitance case (10 x reference), it takes nearly 10 days to eliminate the initial condition effects. For the reference capacitance case, this time period is close to 2 days. Fig. 2 shows clearly the delay and the thermal amplitude reductions regarding the external temperature signal of 2.21h and 2.33°C, 5.71h and 5.07°C and 11.49h and 5.97°C for the respective cases with low thermal capacitance (10% of the reference), thermal capacitance of reference and high thermal capacitance (10x reference). This can be explained by the fact that the higher the wall thermal capacitance the higher the needed energy to change its temperature. The same thing can be interpreted by the envelope thermal diffusivity ($\alpha=\lambda/\rho c$) by changing the thermal conductivity.

The use of Simulink makes easy to analyze the room air temperature behavior integrated to a heating system. In this paper, we considered an on-off control heating system as it can be seen in Fig. 3. The heating system is composed by three 5-kW heaters.

In Fig. 4, it is presented how the temperatures of room air, internal building envelope surface and heater vary with time. We notice from Fig 4 the wall temperature, due to a high thermal inertia, does not vary significantly. There is a delay of 5.08h with a peak-to-peak thermal amplitude of 1.9°C. The controlled room air temperature goes up and down very often due to the heating system control strategies and thermal characteristics. If we zoom part of Fig. 4, we can see, in Fig. 5, small sine-like fluctuations for the wall internal surface temperature due to the heating system temperature variation. These fluctuations would be certainly higher for low mass constructions.

As MATLAB can handle highly non-linear systems, we have considered inter-surface long-wave radiation so that its effect on room air temperature and heater performance can be analyzed. First, we have defined a heater performance coefficient (η), which can be mathematically described as:

$$\eta = \frac{\int_{t_1}^{t_2} h_c A_c [T_c(t) - T_A(t)] dt}{\int_{t_1}^{t_2} \dot{Q}(t) dt} + \frac{\int_{t_1}^{t_2} \sigma \epsilon A_c \sum_{i=1}^m F_{s,c-i} [T_c^4(t) - T_{n,i}^4(t)] dt}{\int_{t_1}^{t_2} \dot{Q}(t) dt},$$

where the first right-hand term is the ratio between the time-integrated convection heat transfer losses and the time-integrated heater power; the second

right-hand term corresponds to the ratio between the radiation heat transfer losses and the heater power. Normally, the radiation term, on the equation shown above, is neglected and we can inspect how its effects in the case studied in this work. The heater performance coefficient for a period of 1 week and an emissivity of 0.8 was calculated as being 99.97%, from which 2% was due to the radiation losses. In the case the emissivity is 0 (no radiation), all the energy released by the heater is instantaneously absorbed by the room air, which gives, for the same equipment, a performance coefficient of 99.99%, which means the radiation effects on the room air heating process delay is very small (about 2% in terms of energy).

In Figures 6 and 7, we can observe, the emissivity effects on room air temperature (Fig. 6) and heater surface temperature (Fig. 7). In these cases, the term *with radiation* means we have used an emissivity of 0.8. and *without radiation* an emissivity of 0.0.

We have noticed that when the external temperature goes down to its lower limit the heater run time goes up from 1058.8s to 1437.5 s. In Fig. 6, we see that the heater surface emissivity does not play an important role on the room air temperature, giving just a short delay of about 5 min. This delay depends on the wall thermal diffusivity. The higher the thermal diffusivity the lower the emissivity effects on room air temperature, which means the air absorb more instantaneously the energy released by the heater.

Fig. 7 shows the heater temperature behavior. We remark this temperature is not very sensitive to the emissivity, giving just a short delay. However, we notice the heater thermal capacitance may not be adequate since it is submitted to a high temperature variation in a very short period of time.

Table 2 shows the heater energy consumption for a 7-day period, making comparisons if the building envelope thermal resistances would be decreased by a factor of 10 and if the heat released by the heater were just given by convection heat transfer (instantaneous gain or null emissivity).

Table 2: Energy consumption for heating for a 7-day period.

	Ref.	10λ	$\epsilon = 0$
Energy Consumption (kWh)	318.9	433.4	313.6

As it was expected, an increase on thermal conductivity represents an increase on energy consumption since the heat flux is directly increased. However, if we disregard the radiation heat transfer effects or the heater surface emissivity is considered to be very low, the energy consumption should be slightly decreased.

CONCLUSIONS

In this work, we have used MATLAB/Simulink for building thermal performance analysis, which shows how practical and fast-to-implement it is.

We have elaborated a dynamic multinodal capacitive lumped non-linear model to describe a building, considering conduction heat fluxes, envelope thermal capacity, lighting and people loads, infiltration, fenestration and thermal inertia of heating systems, which allowed the verification of thermal parameters effects on room air temperature.

The thermal capacitance was analyzed and simulation results demonstrated that high thermal mass buildings can significantly reduce the room air temperature variation.

We have shown that highly non-linear phenomena, such as radiation heat exchanged between walls and a heater, can be easily implemented in MATLAB/Simulink.

In conclusion, we have shown an efficient way for the coupled analysis of building thermal performance and heating systems efficiency by using MATLAB/Simulink

Additionally, it is important to remember that building heating systems constituted by electric resistances, in general, have just on-off temperature control devices. However, the accuracy of this control strategy depends strongly on the construction thermal inertia and there is also, in many cases, a large temperature difference between the on-off set points making the temperature control even worse for fine tune on temperature setting. Thus, for further work, as MATLAB has shown a very high potential to analyze control strategies, we intend to evaluate other strategies than the on-off one which, usually brings higher energy demands. Besides, we intend also to analyze humidity effects when 2 variables have to be controlled.

REFERENCES

- ASHRAE Handbook-Fundamentals, 1993, Atlanta: ASHRAE.
- Athienitis A.K., Stylianou M. and Shou J., 1990, A Methodology for Building Thermal Dynamics Studies and Control Applications, ASHRAE Transactions - SL-90-14-4.
- Clarke, J.A., 1985, Energy Simulation in Building Design, Adam Hilger Ltd., USA.
- Dion J.M., Dugard L., Franco A., Nguyen Minh Tri and Rey D., 1991, MIMO Adaptive Constraines Predictive Control Case Study: An Environment Test

Chamber, Automatica, Vol. 27, No. 4, pp. 611-626, Great Britain.

Hudson G. and Underwood C.P., 1999, A Simple building modelling procedure for MATLAB/SIMULINK, Proceedings of the 6th International Conference on Building Performance Simulation (IBPSA'99), September, Kyoto-Japan, pp. 777-783.

Incropera F.P. e De Witt D.P., 1998, Fundamentos de Transferência de Calor e de Massa, LTC - Livros Técnicos e Científicos Editora, 4ª Edição, Rio de Janeiro.

Mendes N., Araújo H.X. e Oliveira G.H.C., 2000a, O Problema do Controle de Temperatura em Aquecimento de Edificações, VIII Encontro Nacional de Tecnologia do Ambiente Construído (ENTAC 2000), Abril 23-28, Salvador-Brasil.

Mendes N., Oliveira G.H.C. e Araújo H.X., 2000b, O Uso do MATLAB/Simulink para Avaliação do comportamento térmico de ambientes, ENCIT 2000 - 8th Brazilian Conference on Thermal Engineering and Sciences, Anais em CD ROM, Porto Alegre, Brasil.

User's Guide Dynamic System Simulation Software, 1999, MATLAB 5.0, The MathWorks, Inc..

LIST OF TABLES

Table 1: Dimensions and thermal properties.

	ρ (kg/m ³)	c (J/kg-K)	λ (W/m-K)	h (W/m ² -K)	A (m ²)	L (cm)	V (m ³)
Heater (c)	884,1	1909	---	5,0	5	---	0,002
Room (A)	1,16	1007	---	5,0	25*	---	62,5
Sensor (s)	8933	385	---	5,0	1,26e-5	0,1	4,2e-9
Walls and ceiling	2050	950	1,92	5,0	12,5	2	0,25
	1900	920	0,985		12,5	10	1,25
	2050	950	1,92		12,5	2	0,25
Floor	2050	1840	0,52	5,0	25	20	5,00
	998	900	1,4		25	250	62,50
	550	2385	0,2		25	10	2,50

* Floor and ceiling surface area.

LIST OF FIGURES

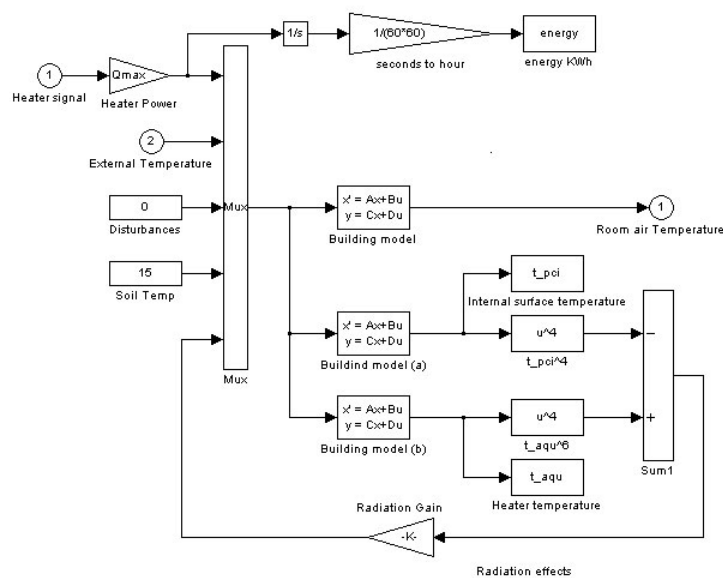

Figure 1 – Modular model scheme by Simulink.

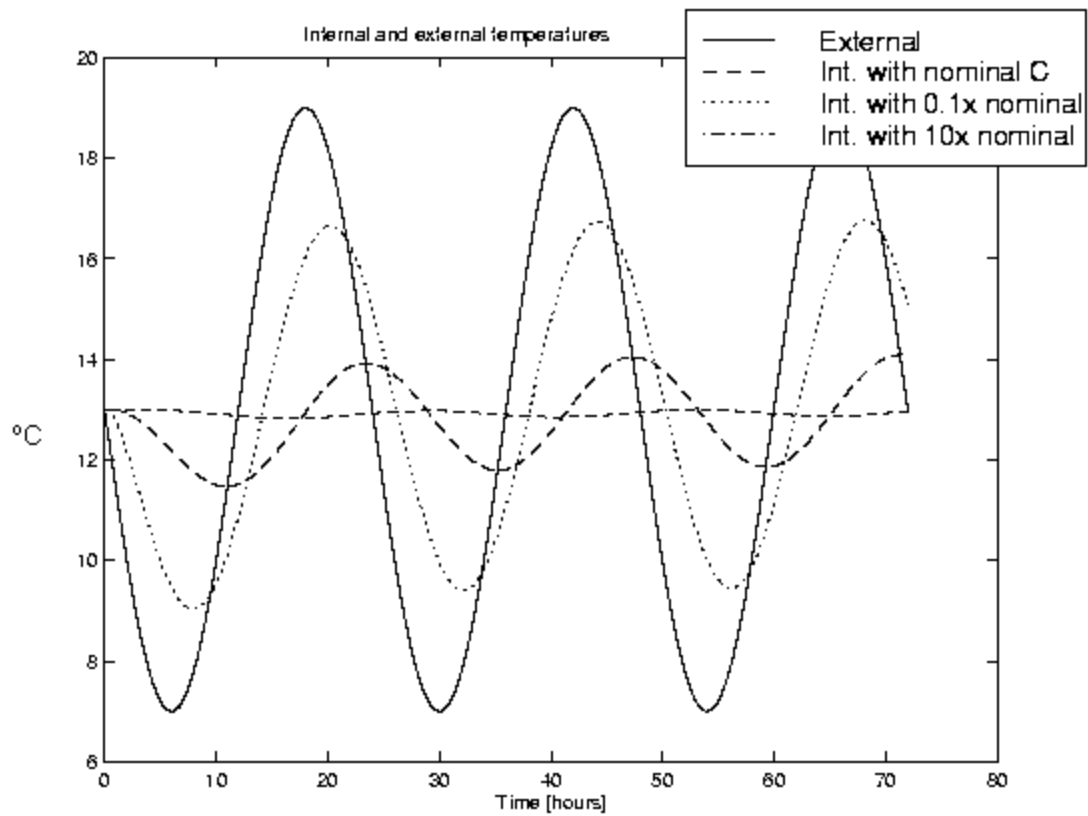

Figure 2: Thermal capacitance effects on the delay and thermal amplitude reduction of $T_A(t)$.

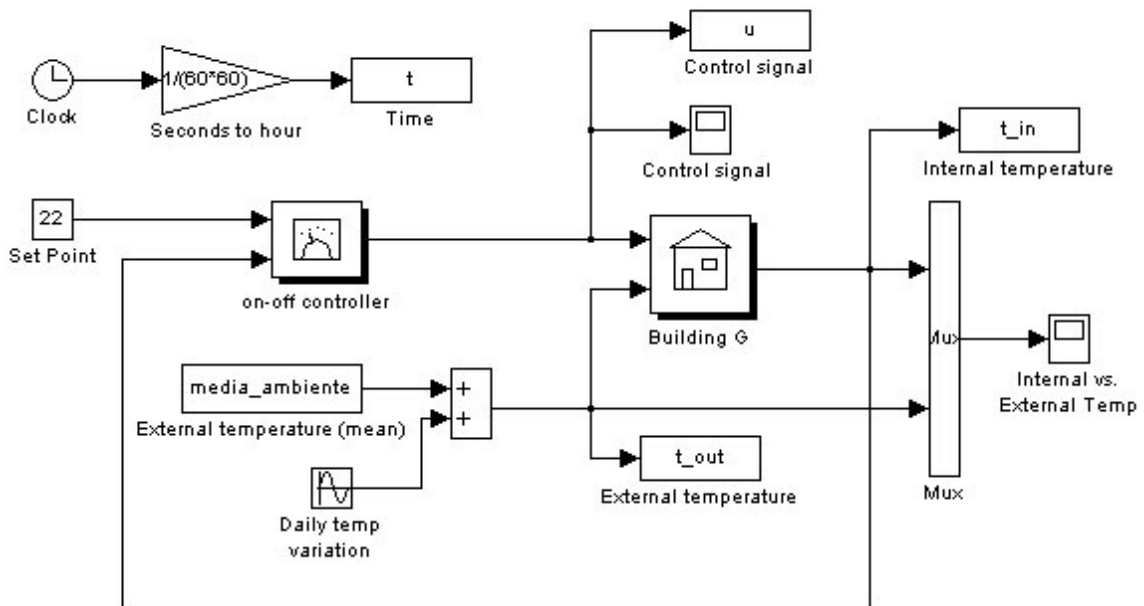

Figure 3: Closed loop for a building on-off control heating system by using Simulink.

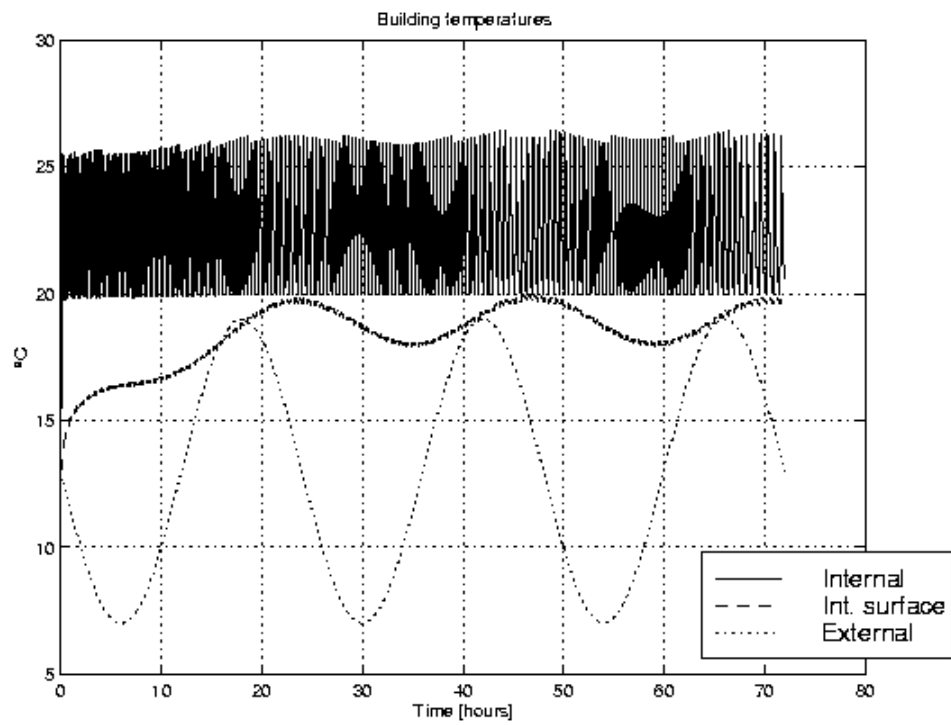

Fig. 4: Temperature variation with time.

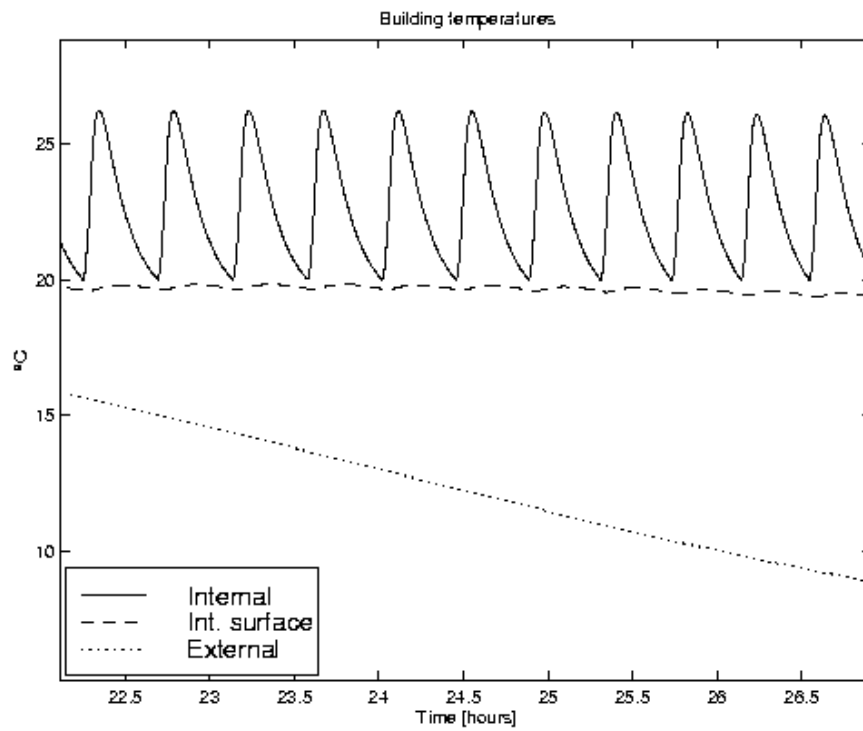

Figure 5: Amplification of internal surface temperature fluctuations.

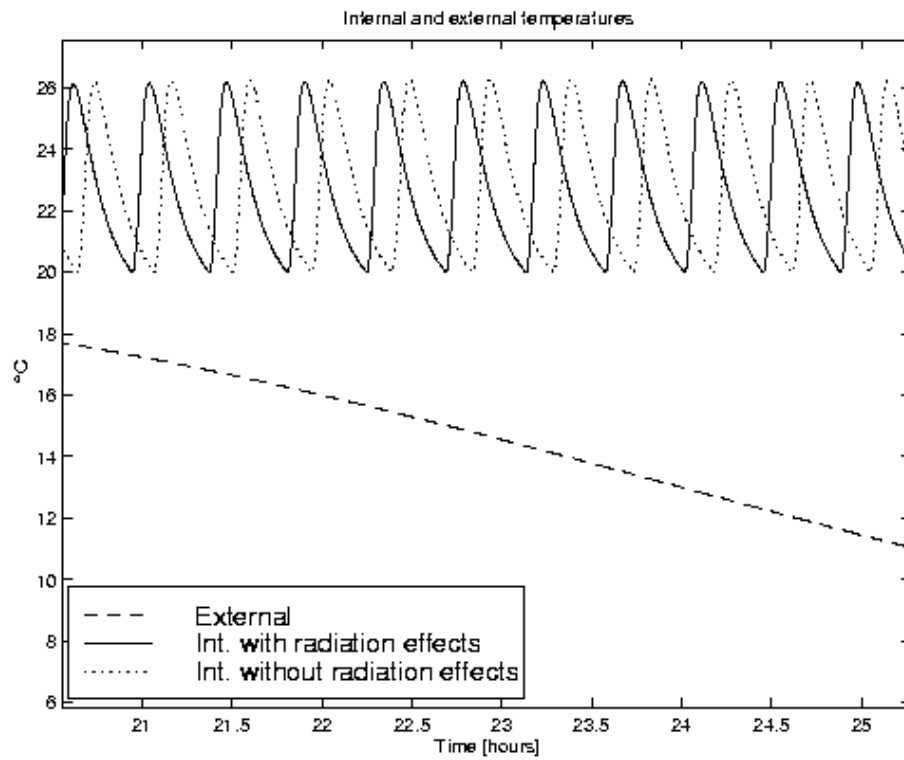

Figure 6: Room air temperature as a function of time and heater surface emissivity.

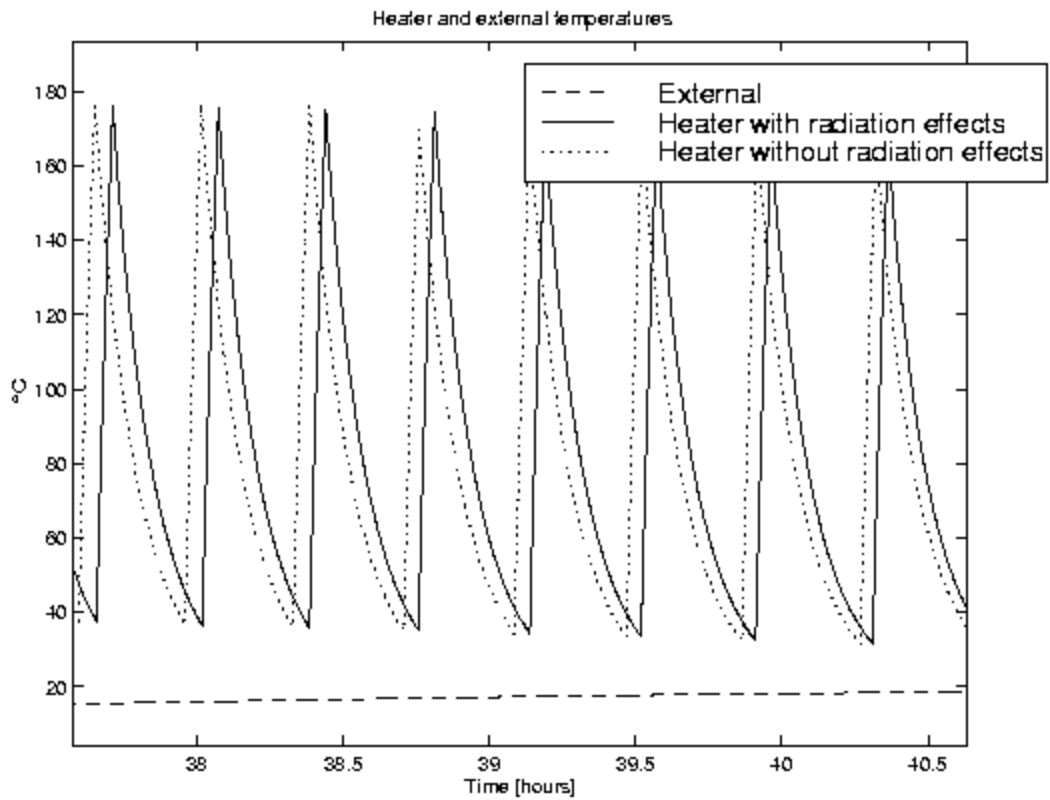

Figure 7: Heater surface temperature as a function of time and emissivity.