

A MODULAR, LOOP-BASED APPROACH TO HVAC ENERGY SIMULATION AND ITS IMPLEMENTATION IN ENERGYPLUS

Daniel E Fisher¹, Russell D. Taylor²,
Fred Buhl³, Richard J Liesen², and Richard K Strand⁴

ABSTRACT

This paper presents the new EnergyPlus HVAC simulation environment, which differs from existing energy analysis programs in three key respects. First, the EnergyPlus HVAC simulation is based on a "manager-interface" protocol that supports multiple solution techniques within the overall context of the simulation. Second, the EnergyPlus HVAC simulation is based on high level component connectivity. Third, the EnergyPlus simulation and component modules enforce a high degree of data encapsulation. These three features together with input and output processing services provided by the environment result in a simulation tool that is ideally suited for collaborative development of component models, evaluation of solution techniques and design of HVAC sub-systems. The paper describes the features of the simulation environment, discusses currently implemented algorithms and includes an example of the type of results that can be expected.

INTRODUCTION

Existing building energy simulation programs can be broadly categorized on the basis of overall structure as either system based, component based or equation based. System based programs tend to use structured languages such as FORTRAN to describe the various system simulation algorithms. Since each algorithm is tightly coupled with a numeric solver; usually a Gauss-Seidel, successive substitution method [Stoecker, 1989a], modifications to existing systems tend to be difficult. Component and equation based systems are more amenable to object based languages and usually implement a Newton type solver, [Stoecker, 1989b] that is de-coupled from the component level algorithms or equations. Both system based approaches and component or equation based approaches have distinct advantages and disadvantages.

Building energy simulations, such as BLAST [BSO, 1989], IBLAST [Taylor, 1990, 1991] and DOE-2 [LBNL, 1989] can be described as system based simulations. These programs model mechanical

systems as either monolithic blocks of code or as a collection of tightly coupled and specialized component based subroutines. This approach is advantageous because it allows the solution method to be tailored to each component and system type. This results in models that tend to be quite robust. In addition, a system-based approach simplifies the input required to describe a particular system or component since much of this information is built in to the structure of the code itself.

On the other hand, there are a number of disadvantages to a system based simulation approach:

- New models are difficult to develop and implement since this requires a working knowledge of a significant fraction of the program data structure and subroutine hierarchy
- Existing models are difficult to change and modifications can significantly alter the technique required to obtain a solution

System based simulations are inflexible and often do not sufficiently represent the significant characteristics of the system or component being modeled.

Programs such as HVACSIM+ [Park, 1985], TRNSYS [Klein, 1976], ESP-r [Clarke, 1996], SPARK [Sowell, 1995] and IDA [Sahlin, 1991] model HVAC systems and mechanical equipment at a component or equation level. Complete systems are defined by the relationship between components or equations. As might be expected, this approach makes it possible to develop a wide range of new systems by connecting different combinations of components or by connecting components in different orders. A sophisticated numeric solver is required to obtain a simultaneous solution among all the simulation elements. In addition, there are a number of potential disadvantages to a component or equation based approach:

- Both the solvers and the language require uniform (often high) model granularity. Complex component connections must typically

1. Department of Mechanical and Aerospace Engineering, Oklahoma State University, Stillwater, OK, USA
2. Building Simulation Laboratory, University of Illinois at Urbana-Champaign, IL, USA
3. Lawrence Berkeley National Laboratories, Berkeley, CA, USA
4. School of Architecture, University of Illinois at Urbana-Champaign, IL, USA

be developed and specified as simulation input. [Vuolle, 1997].

- The solution techniques used in component and equation based approaches tend to militate against the encapsulation of data. The tendency toward global data structures directly and adversely affects the extensibility and maintainability of the code [McConnell 1993]
- The programs are typically constructed around a single solver. As a result all sub-systems of the simulation must be specified and solved to a similar level of detail. Tailoring solution techniques to specific sub-systems is usually difficult or impossible.

The EnergyPlus HVAC simulation environment is a hybrid implementation of component based and system based environments. The presence of a ‘fluid loop’, which is an abstract representation of a piping or duct system, provides the structural framework characteristic of system based models. The presence of system components, which are both described and connected to the loop in the simulation input, provides the flexibility characteristic of component based models.

The EnergyPlus HVAC simulation is based on fluid loops and the ability to track fluid properties around each loop by using loop nodes. The simulation is controlled by loop managers which handle initialization, check for convergence and control the simulation of loop components or sub-systems. The loop and loop node specification will support both Newton-Raphson and successive substitution solvers.

The fluid loops and modular, input-connected components support a “manager-interface” simulation protocol. This protocol allows for the independent simulation of sub-systems and facilitates the development of customized solution procedures that are a blend of system based and component based solvers. For example, a SPARK or TRNSYS solution to a particular sub-system can be supported without affecting the system based solution schemes utilized in other sub-systems.

MANAGER-INTERFACE PROTOCOL

Fluid loops and the ability to track fluid properties around each loop by means of loop nodes are key concepts in the EnergyPlus HVAC and mechanical systems simulation. Systems are defined by first specifying hydronic and air loops that represent the ducts and pipes found in a physical system. Components such as fans, dampers, coils, boilers and chillers (or potentially groups of system components such as an HVACSIM+ sub-system) are added to the loops to form a complete system description. The

type and order in which components are specified on each loop determines the system type.

Each fluid loop is separated into two logical simulation blocks. A schematic of a simple plant loop is shown in Figure 1. Two managers—a ‘demand side’ manager and a ‘supply side’ manager—control the simulation of the loop.

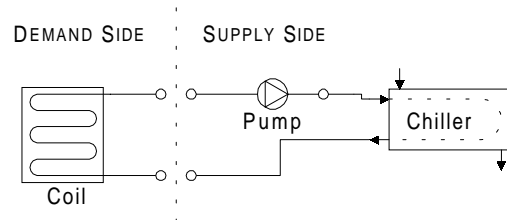

Figure 1. Plant Loop Schematic

The nodes at the interface of the demand and supply sides represent two images of the plant loop state variables at the interface location. This dual image of the data allows for the independent simulation of the supply and demand sides and provides a means of checking convergence between the two sides.

The air handling system and the zones it serves define the air loop; a simple example representing a terminal reheat system is shown in Figure 2. The reheat coils and other components such as, VAV dampers and mixing boxes, which are typically controlled on the basis of zone simulation variables, are simulated on the ‘zone equipment’ side of the loop. Once again interface nodes and component inlet and outlet nodes completely specify the conditions in the loop.

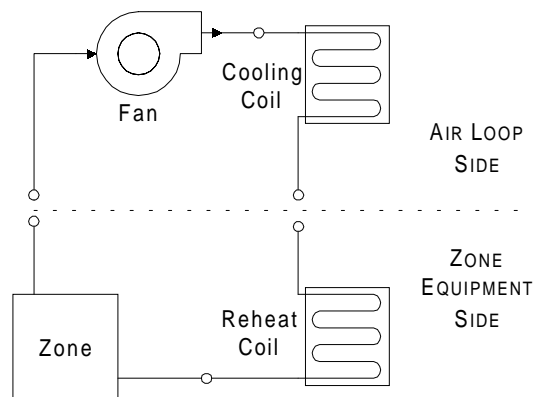

Figure 2. Air Loop Schematic

The manager-interface protocol establishes the direction of flow in each loop, enforces the loop’s convergence criteria, and updates loop node setpoint information. Each loop manager controls the simulation of the components attached to its side of the loop independently of the other managers. The interface passes the most recent state variable

information from the outlet of one loop to the inlet of its companion loop.

There are several important benefits of the manager-interface protocol. It supports a diverse simulation texture allowing different types of models and solvers to be implemented within the domain of the various managers. It also simplifies the developers task by limiting the scope of the code he must master in order to successfully implement a new model. Finally, the manager-interface protocol supports the links to external subsystem solvers.

A high level manager successively calls the loop manager until the entire system has converged. This high level solution scheme is based on the IBLAST scheme of an adjustable system time step [Taylor, 1991]. The high level manager shortens the simulation time step until overall stability criteria are satisfied. Each loop manager sets simulation flags that are used to share overall convergence information with the other loop managers and the high level simulation manager. The high level manager successively calls the loop managers until the simulation flags indicate that the entire simulation has converged.

COMPONENT CONNECTIVITY

Components are connected to each other and to the fluid loop at loop nodes, which are defined as points on a loop where fluid properties are known and available. The loop node data structure shown in Figure 3 is a de-facto component interface.

```

TYPE NodeData
  CHARACTER(len=Max) :: FluidType
  REAL      :: Temp
  REAL      :: TempMin
  REAL      :: TempMax
  REAL      :: TempSetPoint
  REAL      :: MassFlowRate
  REAL      :: MassFlowRateMin
  REAL      :: MassFlowRateMax
  REAL      :: MassFlowRateMinAvail
  REAL      :: MassFlowRateMaxAvail
  REAL      :: MassFlowRateSetPoint
  REAL      :: Quality
  REAL      :: Press
  REAL      :: Enthalpy
  REAL      :: HumRat
  REAL      :: HumRatMin
  REAL      :: HumRatMax
  REAL      :: HumRatSetPoint
END TYPE NodeData

```

Figure 3. Loop Node Data Structure

Fluid type, mass flow rate and standard thermodynamic properties (temperature, pressure, quality, enthalpy, and humidity ratio) are defined at each point. In addition flow rate and set point parameters are attached to the nodes.

High level component connectivity is achieved by assigning an inlet and outlet node to each component and enforcing a standard protocol for retrieving and updating information in the loop node data structure. The loop nodes to which the component is connected are specified as component inlet and outlet nodes as shown in Figure 4. The node data structure connects component models at the loop level, not at the simulation variable level. This important simplification significantly reduces the complexity of component model input at the expense of a small reduction in system configuration flexibility.

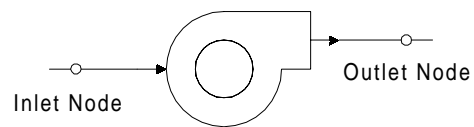

Figure 4. Fan Component Connections

Simulation of the component involves calculating the fluid properties at the outlet node based on the inlet node conditions and the operating characteristics of the component itself. The manager-interface protocol supports a wide range of component model types, ranging from performance models based on operating data to first principle models based on fundamental thermodynamic equations. This flexibility in the specification and support of component models is a result of the fact that each loop may have its own solver—potentially, its own set of solvers. Component models on a loop must be compatible with the loop solver, but are not constrained by unwieldy global data structures, other component models or the requirements of a general simulation solver.

DATA ENCAPSULATION

The modular structure of the simulation code and services provided by the EnergyPlus Input Processor support a high level of data encapsulation. A module is defined as a self-contained set of initialization, computation, control and node update routines. The module's initialization routines use the Input Processor to retrieve input data needed by the module and populate module level data structures.

In general the input format is similar to the module level data structure that it fills. For example, the input format for plant loop parameters is shown in Figure 5 where an "A" prefix indicates an alpha input and a "N" prefix indicates a numeric input. The loop name, fluid type, component list names and operation scheme identifiers are shown in A1-A5). Design flow rates and temperatures for the loop follow in A6-N4.

Finally, loop connections are defined by the inlet and outlet node numbers designated N5-N9.) and

```

PLANT LOOP,
  A1 [Plant Loop Name],
  A2 [fluid type],
  A3 [Demand Side Components],
  A4 [Supply side components],
  A5 [Plant Operation Scheme],
  A6 [Loop Temp Setpoint Schedule],
  N1 [Maximum Loop Temperature],
  N2 [Minimum Loop Temperature],
  N3 [Loop Vol. Flow Rate SetPt.],
  N4 [Max Loop Vol Flow Rate],
  N5 [Min Loop Vol Flow Rate],
  N6 [Supply Side Inlet Node],
  N7 [Supply Side Outlet Node],
  N8 [Demand Side Inlet Node],
  N9 [Demand Side Outlet Node];

```

Figure 5. Plant Loop Specification

The component lists show the component type, name and loop node connections. The type and order in which components are specified on each loop determines the system type. This information fills analogous data structures in the plant loop manager and condenser loop manager modules.

Components are generally grouped by type in simulation modules. A Component model specification includes two identifiers (a keyword and a unique component name), all input parameters required by the component algorithm and the component loop connections.

Figure 6 shows the input specification for a simple chiller. The last four numeric inputs are the component loop connections. In this case, the component is connected to two fluid loops—a condenser loop and a plant loop. This structure is reflected by a derived type in the Chiller simulation module.

```

CHILLER:CONSTANT COP,
  A1 [Chiller Name],
  N1 [Nominal Capacity],
  N2 [COP],
  N3 [Design Evap. Flow Rate],
  N4 [Design Cond. Flow Rate],
  N5 [Plant Loop Inlet Node],
  N6 [Plant Loop Outlet Node],
  N7 [Condenser Loop Inlet Node],
  N8 [Condenser Loop Outlet Node];

```

Figure 6. Component Model Specification

The high level of data encapsulation achieved by the Energy Plus modular structure is advantageous for several reasons. Extending or modifying an existing computational module is greatly simplified by the fact that local rather than global data structures are defined, populated and used by the developer. The developer is spared the sometimes daunting task of deciphering a large global structure and determining

which part of that structure is applicable to his module. Modifying or extending an existing data structure is also simplified by the narrowly defined scope of the simulation variables. Similarly, adding a new data structure with its associated input becomes a trivial task. Finally, errors associated with the modification or extension of existing data structures are contained in a single module and cannot be propagated to other simulation modules.

BETA IMPLEMENTATION

A beta version of EnergyPlus has been developed with successive substitution solvers implemented in each of the loop managers. Both ‘rule based’ controls and ideal controllers that are tailored for specific applications are supported by the implementation. Detailed representations of actual controllers that can be applied to specific types of components are not supported.

Two levels of Air loop control have been implemented with the solution scheme. First, there is a high level controller, the Setpoint Manager, which sets the desired conditions at nodes around the air handling system loops according to parameters and schedules specified by the user. There is also a lower level of control that simulates ideal system controllers by acting on the inlet flow conditions to individual system components.

An application of this type of controller is one that sets the coil outlet air temperature by varying the inlet water flow rate as shown in Figure 7.

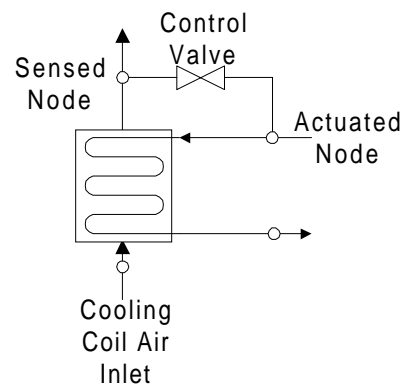

Figure 7. Cooling Coil Control

Air loop controllers update the value of the actuated variable using previous values of the sensed and actuated values modified by a pre-set, normalized gain.

Currently the plant loop manager, the condenser loop manager and the zone equipment manager use rule-based schemes to operate the loop equipment. Although these managers will support component-based controls, the performance based models

currently implemented in EnergyPlus cannot support a detailed component control algorithm.

For Example, performance based plant models are suited only for ideal control based on their part load performance or for a 'load range' based scheme that specifies the operating sequence of the equipment in the simulation input. Figure 8 shows how a plant operation scheme is specified in input. The upper and lower limits of the load range and the name of the load range equipment list are specified under the 'Load Range Based Operation' keyword. The equipment in each list is specified under the 'Load Range Equipment List' keyword. Equipment is listed in order of operating priority (from highest to lowest).

```
LOAD RANGE BASED OPERATION,  
  A1 [Name of Operation Scheme],  
  N3 [Upper], N4 [Lower], A5 [List],  
  N3 [Upper], N4 [Lower], A5 [List],  
  N3 [Upper], N4 [Lower], A5 [List],  
  
LOAD RANGE EQUIPMENT LIST,  
  A1 [Equip List Name],  
  A4 [Equip Type], A5 [Name],  
  A4 [Equip Type], A5 [Name],
```

Figure 8. Plant Operation Input Specification

The zone equipment, following a traditional system based simulation model, uses the zone load as the sensed control variable. The sensed load is calculated based on the zone air setpoint temperature, which is a user input and equivalent to a thermostat within the zone. In the zone equipment simulation, the system heating or cooling output to the zone is calculated and compared to the zone load, which is also effectively the required system output. As in the air loop simulation, controllers are used to adjust the operation of the zone equipment components so that the difference between the actual and required system outputs is minimized. Once the system output is calculated on this basis, it is used in the zone air heat balance to update the zone air temperature.

EXAMPLES

In the following examples, each loop is simulated by stepping around the loop, in the flow direction, from one component to the next. In the first example, for which results are presented in Figures 9 and 10, a three zone building served by a constant volume dual duct system was simulated. The system consisted of a single fan upstream of a splitter. One branch of the splitter fed into a cooling coil, the other into a heating coil. Each coil was controlled to a constant outlet temperature by adjusting the supply water flow rates. On the zone side of the system, each zone had a mixing damper that provided air at a temperature appropriate for the load experienced by the zone. During the winter design day, the zone was controlled

to 22°C during the day with a nighttime setback to 18°C. The decrease in the daytime heating load is due to the presence of scheduled internal heat gains. During the summer design day, the zone was controlled to 24°C during the day with a nighttime setback to 35°, although the cooling coil was also scheduled off during this period. As can be seen from the results shown in the figures, the system is able to control the zones to the desired temperature very accurately. Other features of note are the large "pick-up loads" that occur when the system comes out of setback around hour 8 of the simulation (7am).

The second example, for which results are given in Figures 11 and 12, uses the same three zones as in the previous case but now served by a Variable Volume system with reheat coils on each zone to adjust the supply air temperature. Again, the zone temperatures are controlled very accurately and with stability. Note that for the summer design day, zone 1 does experience some reheat coil energy use presumably because it has the least thermal mass of the three zones.

SUMMARY AND CONCLUSIONS

The EnergyPlus HVAC simulation environment provides a context for implementation and development of a range of solution techniques and component models. The manager-interface protocol provides the high level structure and control necessary to achieve overall convergence of the simulation. The loop-node definition enforces straightforward coupling of components to form various system configurations, and a well defined local data structure and input processor limit the scope of simulation variables and facilitate extension and modification of the simulation modules.

Researchers, developers and users will all benefit from the unique features of the environment. Researchers and developers can focus on an area of interest in one loop manager without affecting solution techniques or data structures in other loop managers. Component model compatibility is enforced only at the loop manager level allowing for various types of models in the various loop managers. Input processing services are readily available and easily implemented. The overhead normally associated with extending an input language is virtually eliminated in the EnergyPlus environment. Users will find the EnergyPlus input files to be both readable and organized in a logical fashion. The current implementation, in the tradition of IBLAST and DOE-2, requires the same type of input with additional information to define loops, nodes and controls.

A short-time step, successive substitution scheme that makes use of the inherent structure of an HVAC 'fluid loop' in defining system models has been implemented. In this implementation, loop managers utilize both rule-based control algorithms and ideal controller models to control the simulation of equipment components.

Continued development of the environment is the subject of an ongoing investigation. The examples presented in this paper, which demonstrate the performance of a constant volume dual duct system and a variable air volume system, are representative of the type of simulation results one can expect from the Beta Implementation of EnergyPlus

ACKNOWLEDGEMENTS

The authors wish to acknowledge of the Building Technology Group in the Department Of Energy for the continued support of this project.

REFERENCES

BSO, *BLAST Technical Reference Manual*, BLAST Support Office, University of Illinois, 1991.

Clarke J A *The ESP-r System: Advances in Simulation Modelling*, Building Services Journal, pp27-9, May 1996

Klein, S.A., W.A. Beckman and J.A. Duffie, *TRNSYS—A Transient Simulation Program*, ASHRAE Transactions 82 (1), 1976, p 623-633

LBNL, *DOE-2 Reference Manual*, Lawrence Berkeley Laboratory and Los Alamos Scientific Laboratory, May 1980.

McConnell, S.C. *Code Complete*, Microsoft Press, Redmond, Washington, 1993, p. 118

Park, C., D.R. Clark and G.E. Kelly, *An Overview of HVACSIM+, A Dynamic Building/HVAC Control Systems Simulation Program*, First Building Energy Simulation Conference Proceedings, Seattle, Washington, USA, IBPSA, 1985

Sahlin, P. and A. Bring. *IDA Solver—A Tool for Building and Energy System Simulation*, Conference Proceedings IBPSA Building Simulation '91, Nice, France, August 20-22, 1991. p339-348

Sowell, E. F., M.A. Mosier, *HVAC Component Model Libraries For Equation-Based Solvers*, Fourth International Conference Proceedings IBPSA Building Simulation '95, Madison, Wisconsin, USA, August 14-16, 1995, p189-196.

Stoecker, W.F. *Design of Thermal Systems, Third Edition*, McGraw Hill, New York, New York, 1989a, p332-334

Stoecker, W.F. *Design of Thermal Systems, Third Edition*, McGraw Hill, New York, New York, 1989b, p123-126

Taylor, R. D., C.O. Pedersen, D.E. Fisher, R. J. Liesen, L.L. Lawrie, *Simultaneous Simulation of Buildings and Mechanical Systems in Heat Balance Based Energy Analysis Programs*, Proceedings of the 3rd International Conference on System Simulation in Buildings, Liege, Belgium, December 3-5, 1990.

Taylor, R.D., C.O. Pedersen, D.E. Fisher, R. J. Liesen, L.L. Lawrie, *Impact of Simultaneous Simulation of Buildings and Mechanical Systems in Heat Balance Based Energy Analysis Programs on System Response and Control*, Conference Proceedings IBPSA Building Simulation '91, Nice, France, August 20-22, 1991.

Vuolle, Mika, Axel Bring, *An NMF Model Library for Building Climate and Energy Simulation*, Fourth International Conference Proceedings IBPSA Building Simulation '97, Prague, Czech Republic, September 8-10, 1997, p181-187.

ADDITIONAL FIGURES

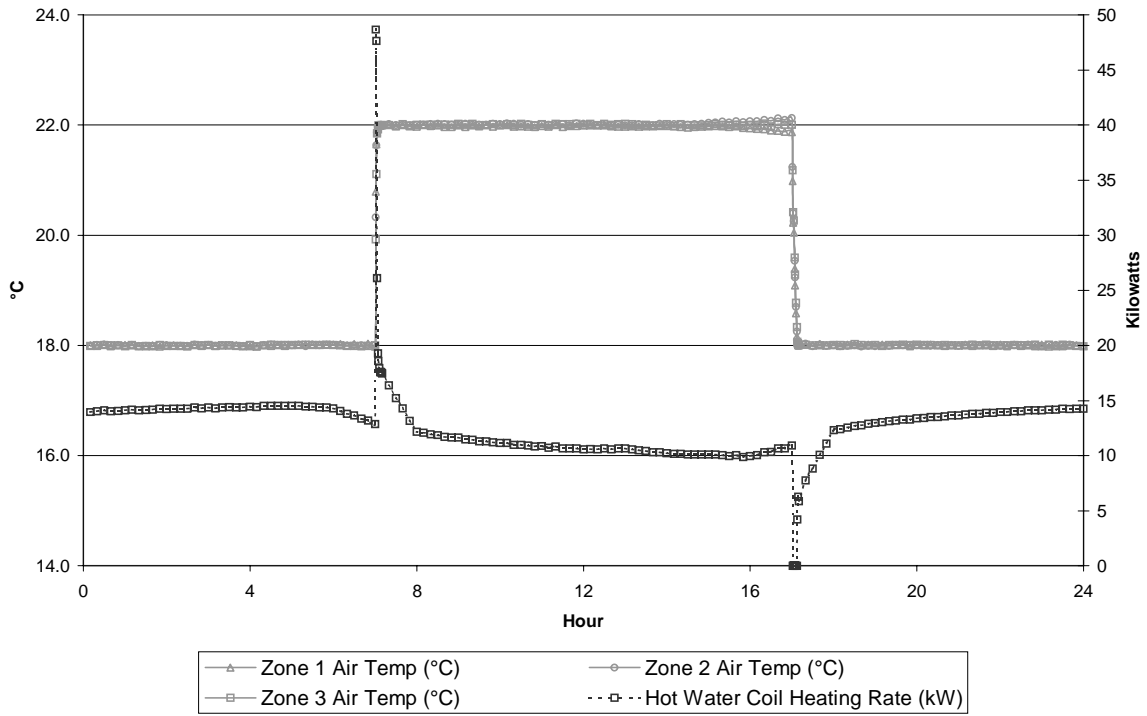

Figure 9. Dual Duct System Response – Winter Design Day

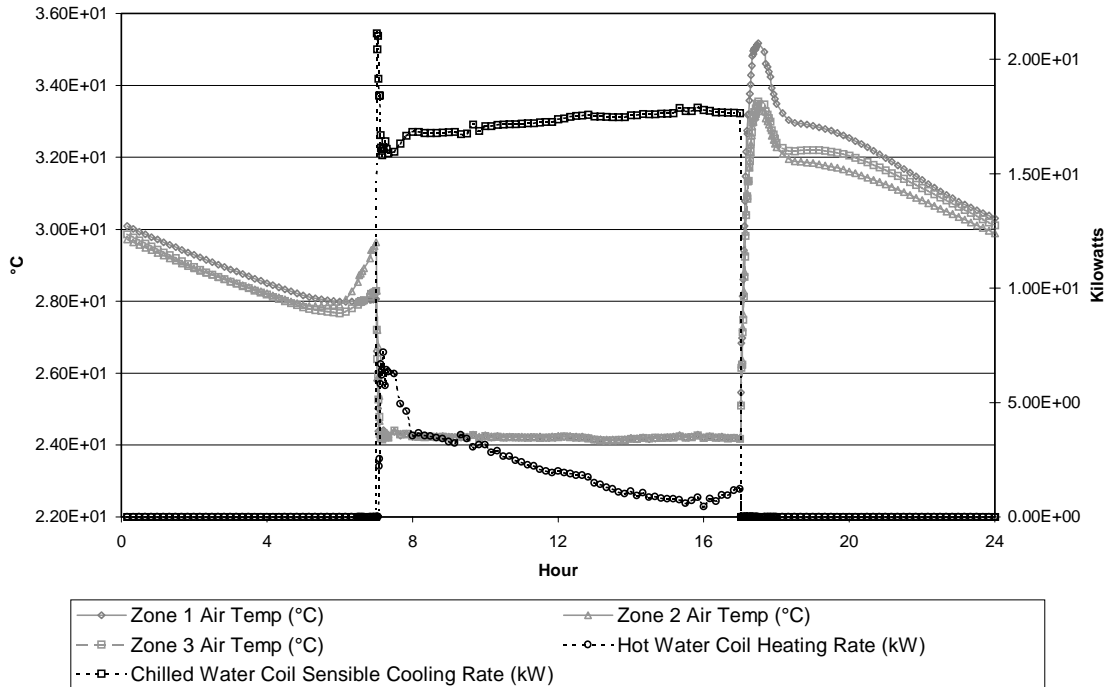

Figure 10. Dual Duct System Response – Summer Design Day

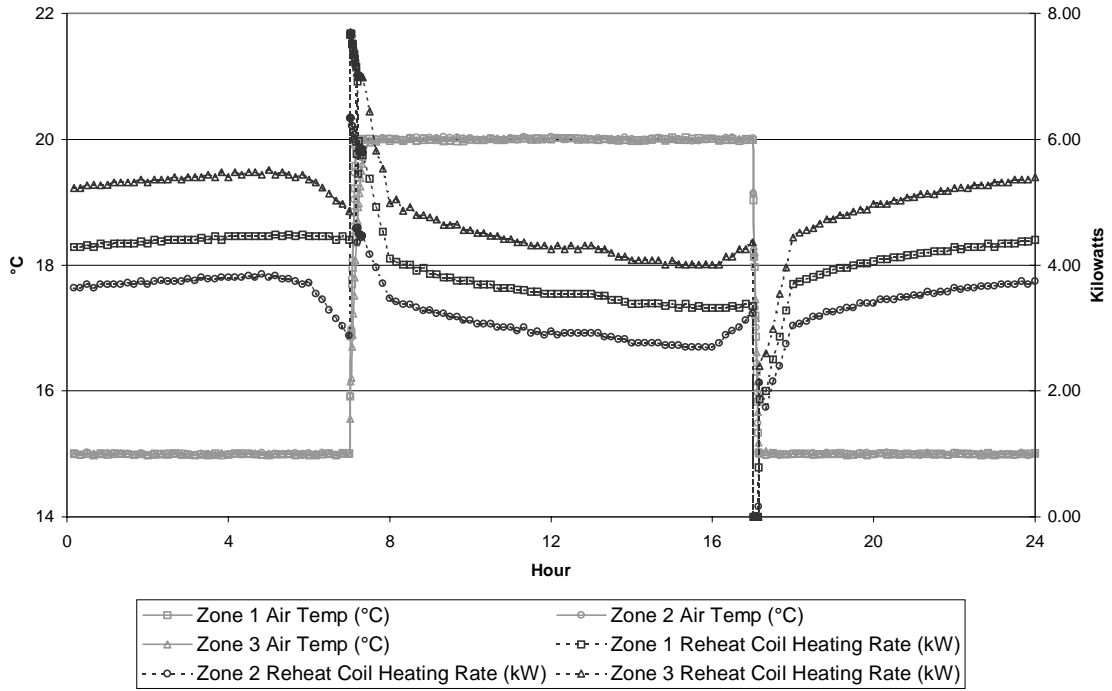

Figure 11. VAV System Response – Winter Design Day

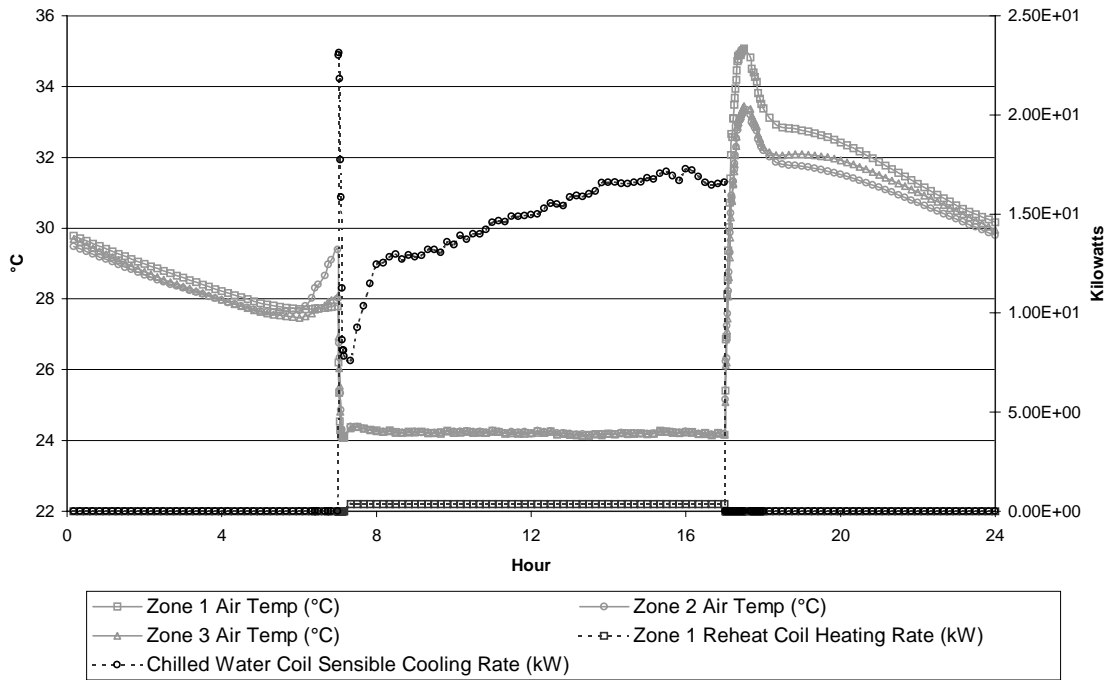

Figure 12. VAV System Response – Summer Design Day